

Leak Tester 3925 – 0065

Operating Instructions

EN 3925-0065 V207-00 MANUAL R01

Please read these instructions, **before** installing, starting up, storing or handling this device.



Any trademarks referred to in this manual are the
sole property of the corresponding owner.

HeMaTech Prüftechnik GmbH & Co. KG
Siemensstrasse 7
DE-71409 Schwaikheim
Phone +49 (0)71 95/13 69 0
Fax +49 (0)71 95/13 69 29
Internet <http://www.hematech.de>

© 2010 All rights reserved

Edition 07/2010

EN 3925-0065 V207-00 MANUAL R01

Contents

Leak Tester 3925 – 0065	1
Operating Instructions	1
Introduction	7
Concerning these operating instructions.....	7
Intended use	8
Warranty	9
Structure of the manual.....	10
Safety measures	12
Safety notes.....	12
Symbols used.....	14
Product description	15
The differential pressure method.....	15
Performance characteristics	18
Design and working principle.....	19
Scope of delivery	20
View of device.....	21
Control elements.....	23
Installation and start-up	25
Connecting peripheral equipment.....	25
Switching the device ON and OFF	28
Initializing	29
The display	31
Working with the program	32
Using the write protection switch	32
Command reference	34
Program structure	34
Menu 1. AUTOMATIC.....	35
Sequencer	37
Automatic mode without leak simulation	38
Menu 2. MANUAL	39
1. Test	39
1.1 Determination of a reference record.....	40
1.1 Sequencer	42
2. Pressurize (Flooding).....	44
Menu 3. SETUP	46
1. Set parameter (Test program).....	46
1.1 Printout PARAMETER.....	53
1.2 Copying an existing test program.....	55

2. Date & Time.....	56
3. Serial ports.....	57
3.1 Output format Profibus.....	64
3.2 Output format Profinet.....	69
4. Sequencer.....	79
4.1 Printout SEQUENCER PARAMETER.....	81
Menu 4. DELETE.....	83
Menu 5. PRINT MENU.....	84
1. View Program Status.....	84
2. Data Collection.....	85
2.1 Print Data Collection.....	86
3. Operating data.....	87
4. Counter.....	87
5. Backup.....	88
6. Error counter status.....	89
7. Record.....	90
8. Record Reverence.....	92
Menu 6. SETTINGS.....	94
1. Display.....	94
2. System parameters.....	96
3. Pressure control.....	98
4. System status.....	100
5. Options.....	101
Testing and Setup.....	103
Testing the leak tester.....	103
Setting up the device for specimen.....	105
Maintenance.....	106
Maintenance contract.....	106
Maintenance plan.....	106
Errors, Causes and Remedy.....	107
Acknowledging error messages.....	107
Trouble Shooting Chart.....	108
Signal Exchange with Machine Control.....	112
Automatic operation.....	113
In semi-automatic operation.....	116
Sample printouts.....	120
Protocol printout.....	120
Program parameters.....	121
Result memory.....	122
System parameters.....	123
Appendix.....	125
Plug assignment.....	126

Pneumatic diagram..... 127
EC - Declaration of Conformity..... 130
Contact address: 135

Introduction

In this chapter you will find some introductory remarks concerning the use of this tester, as well as explanations concerning the structure of these operating instructions and the symbols and text markings used in this manual.

The installation instructions for the device address to persons (skilled electricians and service engineers) who are entrusted with the installation and maintenance of the device. These persons must be fully familiar with and strictly follow all regulations concerning electrical engineering.

The installations for operation of the completely installed device are intended for all persons who will use and make adjustments to the device.

Concerning these operating instructions

The following pages will inform you about the proper use of the device in your production or testing environment.

HeMaTech Prüftechnik attaches great importance to the safe, appropriate and economical use of the device. However, this requires that you read these operating instructions thoroughly before you install and use the device. It contains important information, which will help you to avoid dangers and enhance the reliability and service life of the device. Always keep these operating instructions close at hand near the device and read the chapter *Safety measures* for your own safety. Strictly follow all notes, to keep yourself and other members of staff out of danger and to avoid material damage.

If you have any questions concerning work with the device, for which you have not found an answer in these operating instructions, please contact:

HeMaTech Prüftechnik GmbH & Co. KG

Siemensstraße 7
D-71409 Schwaikheim

Phone +49 (0)71 95/13 69 0

Fax +49 (0)71 95/13 69 29

www.hematech.de

Intended use

The leak tester 3925-0065 from HeMaTech Prüftechnik is solely intended for professional use in leak testing of work pieces by means of compressed air. Any use beyond these limitations is considered unintended. The user solely bears any risks.

Installation and maintenance of the device must only be performed by skilled electrical engineers.

Type plate

The type plate with model designation and serial number is located on the back

HeMaTech Prüftechnik GmbH & Co. KG	
Siemensstraße 7 D 71409 Schwaikheim	
Phone: +49 (0)71 95 – 13 69 0	
Fax.: +49 (0)71 95 – 13 69 29	
www.hematech.de	
Type:	_____
Serial-No.:	_____
Version:	_____

of the device.

You require this information when consulting our Customer Service Department. Please record this information in the following table, so that it is at hand when needed:

Device type	
Serial-Number:	
Software-Version	

Information about the software version can be found under 6. Settings / 2. System parameters

Ordering spare parts

Use only original spare parts from HeMaTech Prüftechnik. If you would like to order accessories or spare parts, you not only need to specify device type and serial number, but also article number and designation of the required components, which you can take from the list of consumables and spare parts.

Article number:	
Designation:	

Reporting transport damage

If you discover any transport damage when unpacking the device, you should immediately contact the forwarding agent to report the loss or damage. Please ask for a corresponding confirmation and return the package to us together with this confirmation and the delivery note.

Preparing a return delivery

Pack the article with all accessories (see scope of delivery) in the original packing material and return the goods to us, together with an exact fault description and the delivery note. Please frank the delivery.

Warranty

The warranty conditions for devices from HeMaTech Prüftechnik GmbH & Co. KG can be found in our terms and conditions of sales and delivery.

If no other agreement has been made, the warranty period for design, material and manufacturing faults (except consumables), as well as for the omission of explicitly guaranteed properties, is generally 1 year, starting from the date of delivery.

We reserve the right to decide whether we will rectify a fault, deliver replacement or submit a credit note covering the value of the goods.

In case of unintended use and damage caused by falling, water, dirt or any other external effects, warranty claims will become null and void.

Any malfunctions and damages caused by the user, such as soiling, faulty connections and mechanical damage are excluded from warranty.

We reserve the right to invoice the repair costs for parts which had been returned for warranty repair, but for which no or only partial warranty could be claimed.

If not agreed upon differently beforehand, HeMaTech Prüftechnik will only bear the shipment costs for outgoing deliveries of devices and parts which are covered under warranty.

However, if the delivery arrived with costs for HeMaTech Prüftechnik, these costs will be added to the repair costs.

Import and/or export duties as well as costs arising for third parties must be borne by the customer.

Structure of the manual

This manual contains the description, installation and operation of the device. It consists of the following chapters:

Safety measures

Read and follow these safety notes, because they serve the safety of persons and ensure the reliability and operational safety of the device.

Product description

Here you will become familiar with the device and its modules, functions and control elements.

Installation and start-up

You must prepare the place of use for the device and provide the necessary supply connections.

Operation

Once all preparations have been made switch on the device, set the test parameters and start the test device.

Command reference

Here you find a complete description of the control software with all possible settings.

Maintenance

Apart from the list of maintenance intervals, this chapter also contains the trouble shooting chart with information on faults, causes and possible remedy.

Signal exchange

This section shows which signals are used in operation with a machine control.

Sample printouts

In this section you find some examples for printouts of measurements, parameters, etc.

Appendix

This chapter contains wiring diagrams and technical data for the device.

The index

The index helps you to find required text passages quickly.

Representation**Bold type**

Designations of control keys are printed **bold**.

Italic type

Cross-references to other chapters or text passages are printed *italic*.

Operating steps

Operating steps are marked as follows:

- Turn key switch clockwise.
Write protection is disabled, entries can be made.
- Make all following entries and confirm these individually by pressing the **ENTER**-key. The insertion point jumps to the next field.

Lists

Lists are marked as follows:

- Variant A
- Variant B
- Variant C
- ...

Safety measures

Safety notes

Thoroughly read and strictly follow these safety notes. They serve your own safety, the safety of other members of staff and help to avoid damage to the device and accessory parts.

Danger caused by electric current

Make sure that no fluid can enter into control cabinet, control panel or other parts of the housing. If this should happen, immediately disconnect the device from the electric power supply, secure the corresponding socket against reconnection and inform appropriately trained expert personnel or the customer service department of HeMaTech.

Make sure that the electrical connecting leads are free of damage and well protected against buckling or squashing. If you detect any damage, immediately disconnect the device from the electric power supply, secure the corresponding socket against reconnection and inform appropriately trained expert personnel or the customer service department of HeMaTech.

Work in the electrical system – e.g. changing fuses – must only be performed by trained expert staff. Further maintenance and repair work must only be performed by the customer service of HeMaTech Prüftechnik or by persons who have been authorized by HeMaTech Prüftechnik.

Use this device and any connected devices only on a dedicated electric voltage.

Strictly follow all warnings and instructions given on the device.

If smoke or pungent smells causes suspicion of a defect, you should disconnect the device from the mains supply and from any other equipment.

Take care that no other objects find their way into the inside of the device. These may come into contact with live parts or cause a short-circuit, which in turn could cause a fire or electric shock

Before starting cleaning work disconnect the device from the mains supply and from all other devices. Use only a slightly damp cloth to clean the device, do not use fluids and sprays!

Disconnect the device from the mains supply if it is not to be used for a longer period of time. Store the device only in dry and weather protected rooms.

If safe operation of the device can no longer be assured, you must disconnect the device from the mains supply and secure it against being switched on again unintentionally.

Risk-free operation is, for example, no longer possible,

- if device or supply lead are visibly damaged,
- if the device does not work properly,
- if the devices was exposed to moisture or rain,
- if condensation water has accumulated,

- if objects have found their way into the device,
- if the device does not work properly, despite orderly performed operating steps,
- if the permissible storage or operating temperature is exceeded or fallen short of.

Installation

The installation measures described in this manual must only be carried out by trained specialists. The applicable regulations for electrical engineering must in any case be observed and complied with.

The device must stand in a firm position, protected against vibration. Avoid locations near heating or air conditioning systems.

Only install the device inside a control cabinet, if adequate ventilation is assured.

Operation

Ensure unrestricted circulation of air around the device. In case of insufficient ventilation the device will overheat. This may result in severe damage to the device and further material damage.

Maintenance

The maintenance work described in this manual must only be carried out by trained specialists. The applicable regulations for electrical engineering must in any case be observed and complied with.

Only perform the maintenance work described in this instruction manual. Any work beyond these limitations can cause damage to persons, material or device.

Repair

Do not carry out any repair work that is not explicitly permitted in these operating instructions. Consult the customer service department of HeMaTech Prüftechnik GmbH & Co. KG.

Unprofessionally performed work can cause damage to persons, material or device.

Symbols used

Thoroughly read and strictly follow these safety notes. They serve your own safety and will help you to avoid damage to the device.

The following symbols are used in this instruction manual:

**DANGER!**

This safety note points to dangers, which could cause fatal injuries or severe damage to persons.

**ATTENTION!**

This safety note draws the attention to dangers, which could cause material damage or incorrect tests.

**NOTE!**

This symbol highlights hints and special features, which will ease the operation of the leak tester.

Product description

The Leak Tester 3925 - 0065 is a device for pneumatic and thus non-corrosive leak testing of series production parts, such as fittings, pump housings, cylinder blocks, vacuum controls, batteries and many more. Its function is based on the differential pressure method.

The differential pressure method

This method is particularly suitable for use in series production, because it can be easily automated with sufficient accuracy.

The test medium is low cost compressed air. Due to its low viscosity it can pass through existing porosities and other leak points with sufficient speed. The test does not generate any dirt. Cleaning and drying as well as corrosion protection measures are not required. Maintenance of the measuring system is unproblematic. Prerequisite for this method is the leak tightness of measuring system and testing device.

As already indicated by the name **differential pressure method**, the pressure difference in the measuring branch caused by a leak in the specimen is compared with the pressure in the blocked off reference branch.

Function schematic of differential pressure test

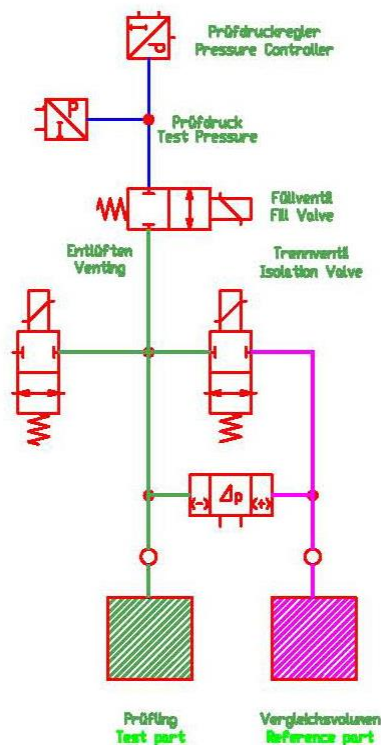

HeMaTech Prüftechnik GmbH & Co.KG
D 71409 Schwaikheim
Germany

The testing process consists of three phases:

1. Filling

With the filling and isolating valve open, the testing pressure set on the pressure regulator is applied to reference volume, measuring transducer and specimen. The filling time is determined by the performance of the pressure regulator, the total volume of the facility including testing and reference volume, the piping resistance and the cross-section of the valves.

2. Stabilizing

This is the phase of pressure and temperature stabilization in the entire system. The reference volume shown in the illustration – one normally uses a pressure tight original work piece – serves the purpose of creating the highest possible symmetry level between testing and reference circuits. This enables a reduction of stabilization time, because possibly existing interfering influences affect both circuits of the system and thus reduce the effect on the measuring result.

3. Measuring

The actual measuring phase starts after the stabilization time has expired. By closing the filling and isolation valves the measuring and reference branches are separated from each other. If the specimen has a leak, the pressure in the measuring branch will drop in comparison to the reference branch. The measuring transducer shows the resulting pressure difference in the measuring value display. If the pressure difference exceeds the preset limit value during the measuring phase, a signal *Reject* will be submitted and the test stopped.

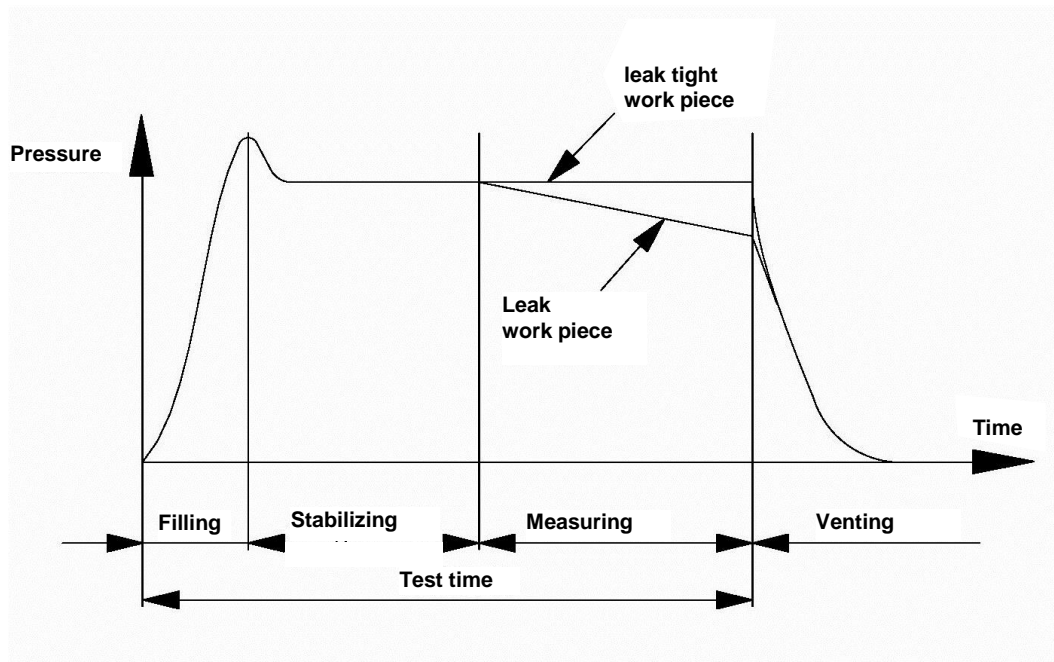

Pressure course in the test system during the test process

The isolating valve shown in the illustration is an isolating valve which has been specially developed for leak testers from HeMaTech Prüftechnik. The special requirements for leak testing were already accounted for in the development of the valve.

Due to the symmetric design, both measuring branches are simultaneously isolated from each other when closing the valve. Volume and pressure differences therefore act uniformly on both measuring branches, whereby measuring faults are ruled out. By distinct separation of both measuring circuits, measuring errors caused by leaks in upstream filling valves are reliably prevented. The isolating valve is pneumatically controlled and heating, caused by e.g. the coil of a solenoid valve, is thus avoided.

Leak testing equipment using the differential pressure method is well established in series production. A vast variety of work pieces and assemblies, ranging from ball-point cartridges to vehicle engine blocks, are reliably tested for leaks.

Performance characteristics

The test device offers the user a number of functions and possibilities to set parameters for measurements, as well as for the output and distribution of these measuring results:

Function monitoring

The device takes over the monitoring of parts and function sequence. The user receives error messages through the plain text display and floating contact.

99 Test programs

There is a possibility to create up to 99 different programs and to select these either via the control panel, or by means of external signals (BCD, 8 bit) in automatic operation.

Data exchange

All test parameters and measuring results can be entered and output, printed or processed further by PC through the serial interface.

Result signals

The device delivers several result signals:

- I.O. (Accept)
- Rework
- Reject and gross leak (gross leak message only through V24 interface)
- Envelope curve,
Filling fault. (optional)
- Fault

The result signals can vary depending on device variant or have different designations.

Fill pressure, underfill pressure, underfill time and test pressure,

are separately set/disabled via keypad for each test program.

Times for fill, stabilization, pause, tare, measure and vent,

are separately adjustable via keypad from 0.1 ... 999.9 seconds for each test program.

Measuring range

Δp 0 ... 3000 Pa.

Resolution 1 Pa; limit contact setting up to max. 2000 Pa
(100 Pa = 1 mbar = 10 mmWC).

Measuring value display

You can switch over to:

PASCAL, mbar, psi, mmWC, mmHg, ml/min

Design and working principle

The test device is microprocessor controlled, of modular design and, due to its division into pneumatic and electronic sections, can be adapted to the most different requirements of customers. The design as a 19 inch plug-in unit (3HE) enables problem free integration into control cabinets. The device dimensions $W \times H \times D$ are:

- for standard housing $357 \times 142 \times 420$ mm

Pneumatics

The pneumatic section of the tester consists of the following main components:

- the pressure control for filling and testing pressure via electronic pressure setting (set up specification by computer) with pressure monitoring by means of an adjustable tolerance window
- a pneumatically controlled isolating valve, which rules out heating of the valve
- a temperature compensating differential pressure measuring transducer
- a high single-side overload protection (max. 1.4 bar/g) of the differential pressure measuring transducer
- pressure sensors for function monitoring of the pneumatic circuit

See also Pneumatic Diagram in the appendix

Electronics

The electronics section of the tester consists of

- microprocessor system,
- battery buffered RAM memory,
- alpha-numerical membrane keyboard for all input functions,
- On/Off switch integrated in the membrane keyboard,
- key switch to protect against unauthorized changing of test parameters and
- graphics display for device menus and up to 2 serial interfaces

Scope of delivery

1 Leak Tester 3925 - 0065

1 Power cable

1 Counter plug to machine control

2 Key for write protection switch

1 Operating instructions

2 Caps

(for specimen connection and reference volume connection)

Should one of these items be missing or damaged, you should immediately consult your supplier.

Accessories

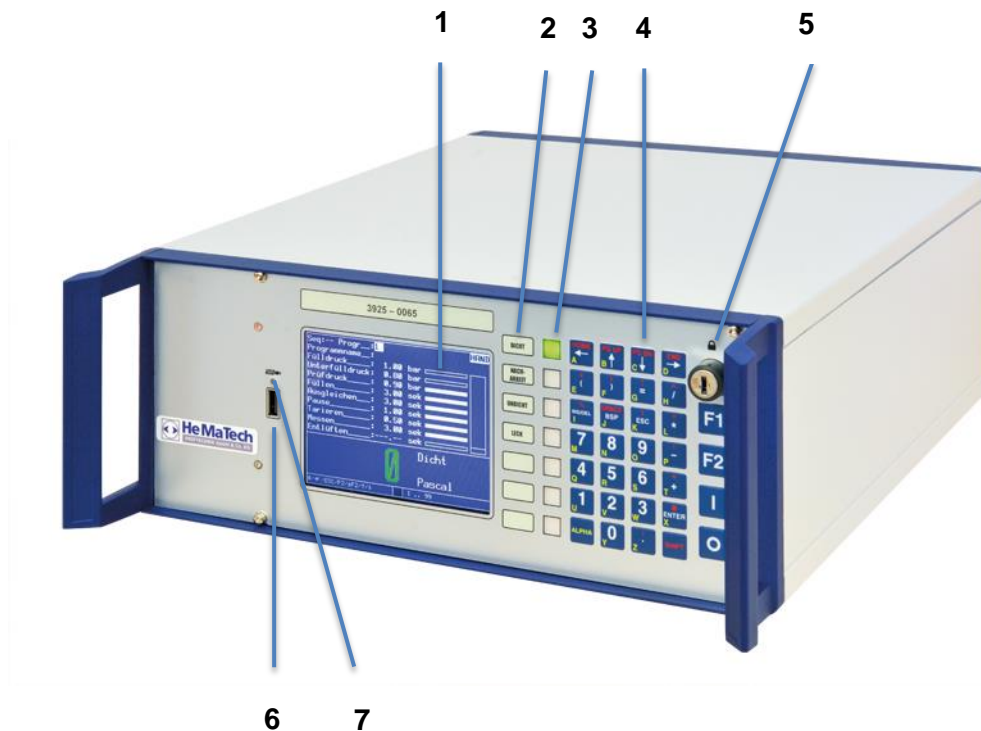

View of device

Front view

- 1 LC-Display
to display the program menus
- 2 Status fields
4 assigned by default, 3 for individual assignment
- 3 LED
to show the current test result
- 4 Alpha-numerical control field
to enter the desired test parameters
- 5 Write protection switch
to protect against undesired changing of test parameters
- 6 USB interface
- 7 LED
to show the working status of the USB interface

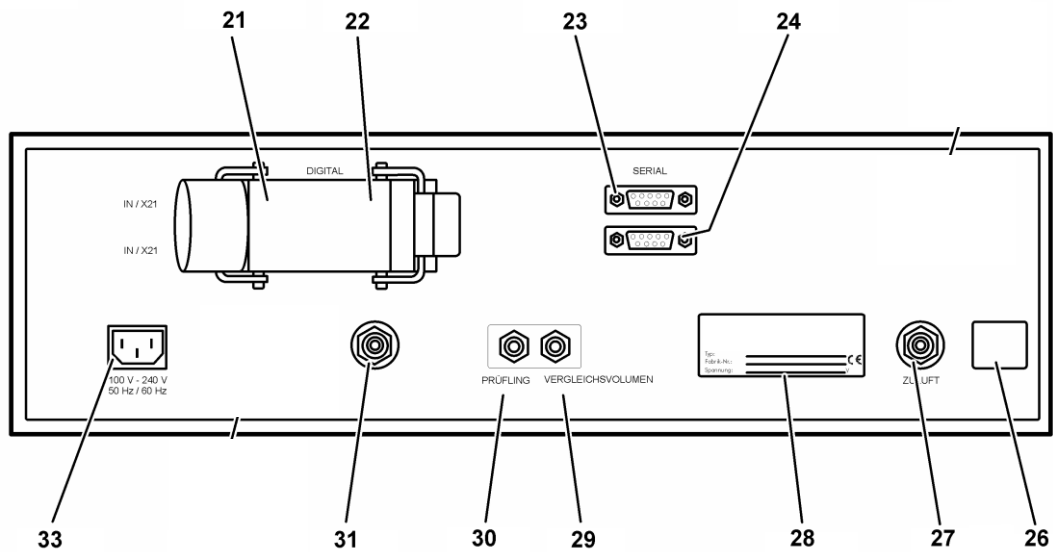
Back view

- 21 7-pin Sub-D socket, digital OUT, X20
- 22 37-pin Sub-D plug, digital IN, X21
- 23 9-pin Sub-D socket, serial, V24 RS232C Ser#1, X22
- 24 9-pin Sub-D socket, serial, V24 RS232C or Profibus Ser#2, X23 (option)
- 26 Table with pressure values for supply air and test media
- 27 Supply air connection, maximum 10 bar/ü, oil free and filtered
- 28 Type plate
- 29 Connection for reference volume (pressure proof original specimen)
- 30 Connection for specimen
- 31 Air relief outlet for silencer
- 33 Power supply socket 100 ... 240 V, 50 ... 60 Hz,
with fuse T 2.0 A

Control elements

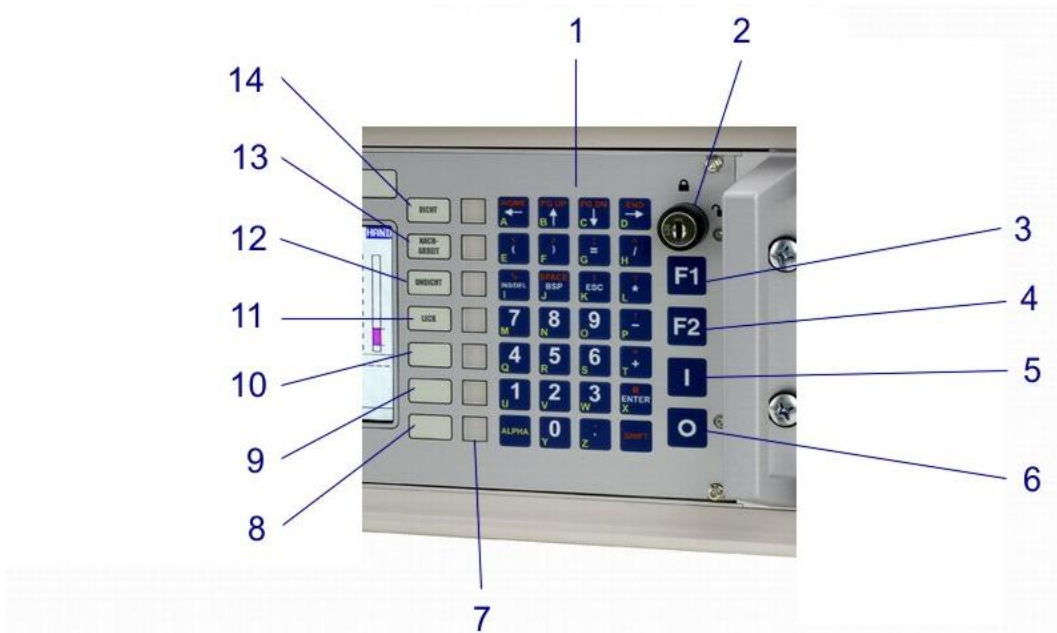

- 1 Alpha-numerical control field
to enter test parameters (see next page)
- 2 Key switch
to enable and disable the write protection
- 3 Key **F1**
function key (output of filling curve measuring data)
- 4 Key **F2**
to enable device functions and to start the test sequence
- 5 Key **I**
to switch ON the device
- 6 Key **0**
to switch OFF the device
- 7 LED's
to show the current test result
- 8 free status field
- 9 free status field
- 10 free status field
- 11 Status field **LEAK**
if the LED next to this status field lights up, the leak simulation is active
- 12 Status field **REJECT**
if the LED next to this status field lights up, the current specimen is leaking
- 13 Status field **REWORK**
if the LED next to this status field lights up, the current specimen is leaking,
but can be reworked

14 Status field I.O.

if the LED next to this status field lights up, the current specimen is with out leak

Control Keys in the alpha-numerical control panel**ALPHA**

The text input can be activated and deactivated by pressing the **ALPHA**-key. When the red LED **ALPHA** lights up, the numerical keypad is not activated. For the input of numerical values you must first activate the numerical keypad.

SHIFT

With the **SHIFT**-key you can enable the input of capital letters and activate the red key functions. You must always press the **SHIFT**-key first, before entering a new character.

ENTER

By pressing the **ENTER**-key you can confirm a previously made input or selection.

Arrow Keys

With the arrow keys in the top row of the keypad you can move the marking in the display to the desired position, i.e. you can control the cursor.

ESC

By pressing the **ESC**-key you can abort a process that had been started and return to the previous menu.

PgUp

By pressing the keys **SHIFT + PgUp** you can scroll one page back.

PgDn

By pressing the keys **SHIFT + PgDn** you can scroll one page forward.

Installation and start-up

The installation measures described in this manual must only be carried out by trained specialists. The applicable regulations for electrical engineering must in any case be observed and complied with.

Preparations



ATTENTION!

Choose an installation location, at which the device is neither exposed to extreme temperatures, nor to extreme humidity. The ambient temperature must be in the range from 0 to 50 °C, the relative humidity must not exceed 90 % and no condensation should occur.

The device must stand in a firm position, protected against vibration.

Avoid a location near heating or air conditioning systems.

Make sure that the supply voltage matches the supply voltage specified on the type plate.

Only install the device inside a control cabinet, if adequate ventilation is assured.

Position the device as close as possible to the specimen, in order to maintain the test circuit volume at a low level and to achieve more accurate measuring results.

Keep a space of approx. 100 mm behind the back of the unit for electric cables, pneumatic hoses and connecting plugs.

Connecting peripheral equipment

Before you can start up the tester, the following connections must first be made: to the compressed air supply, optionally to the test medium, to specimen and reference volume, to the machine control, to the data output through a serial interface and to the power supply. Only then is the leak tester ready for operation.



DANGER caused by electric current!

Separate the device from the electric power supply before connecting device components.

Before connecting compressed air/test medium

In case of major pressure fluctuations in the compressed air supply network we recommend the installation of a pressure switch, which will emit an electrical output signal when the pressure drops. This signal can be used for display/machine shut-down purposes.

Compressed air quality

Cleanliness class of compressed air quality, ISO 8573-1:2010 [3:3:3].

Install a filter unit (min 1µm) in the supply line at a safe and well visible location, to ensure the supply of dry, oil free compressed air. Check the service unit at regular intervals to prevent the device from being soiled by oil. Include the inspection and changing of filter cartridges in the maintenance plan; this applies also for filters with automatic condensate drainage.

NOTE!

Warranty claims will not be accepted if the tester is damaged by oil and/or water entering into the unit.

Connecting compressed air

The supply air connection, for supplying the leak tester with compressed air, is located on the back of the device. The supply air connection has a G $\frac{1}{4}$ " fitting for a 8/6 mm hose.

The supplied compressed air must be oil free and filtered. Please make sure that the compressed air to be connected has a constant pressure of approx. 1.5 bar above the filling or testing pressure (min. 5.0 bar/ü, max. 10 bar/ü, see also pressure table on back of housing).

Before connecting the air supply make sure, that the compressed air hose is undamaged and will not be kinked or squashed. The hose must be not pressurized free.

After connecting the hose, tighten the spigot nut of the fitting and check for tight fit.

Connecting specimen and reference volume

Two fittings G $\frac{1}{8}$ " for 8/6 mm hoses for connection of a specimen and a reference volume are arranged on the back of the tester. The dimensions of the hose connections may vary in dependence on the version of the device (test volume).

In order to prevent any expansion (breathing), the hose should be of appropriate strength. A suitable hose (PA-tube) is available from us.

Hose 4/2; max. 45 bar at 20 °C; Order-No. 8082-0354

Hose 6/4; max. 27 bar at 20 °C; Order-No. 8082-0379

Hose 8/6; max. 19 bar at 20 °C; Order-No. 8082-0381

Hose 10/8; max. 15 bar at 20 °C; Order-No. 8082-0382

Make sure that the supply lines to specimen and reference volume are pressure tight. The lines must be as short as possible. Avoid the use of plug-type fittings, because these could cause leakages in the testing circuit.

If possible, use a pressure tight original specimen as reference volume. With a test volume < 5 000 ml the connection of a reference volume is not necessary. For thin-walled or elastic specimen the connection of a reference volume may be necessary, even for small volumes. If you do not connect a reference volume, you must close the reference volume connection with the blind cap provided for this purpose.

Before connecting the reference volume make sure that the hoses for test medium and reference volume are undamaged and will not be kinked or squashed. The hoses should not be pressurized.

NOTE!

If you do not connect a reference volume, you must close the reference volume connection with the blind cap provided for this purpose.

After connecting the hose to the specimen connection, tighten the spigot nut of the fitting and check for tight fit.

After connecting the hose, tighten the spigot nut of the fitting and check for tight fit.

If necessary plug the hose to the reference volume connection, tighten the spigot nut of the fitting and check for tight fit.

Connecting the machine control

There are several possibilities for communication between tester and machine control:

1. Parallel interface

- the 37-pin Sub-D socket, digital OUT, X20 (position number 11, on back), for output signals
- the 37-pin Sub-D socket, digital IN, X21 (position number 12, on back), for input signals
- Wire the plugs first according to the *plug assignment diagram* in the *appendix*.
- Provide a suppressor circuit (g.g. varistor or diode) for all output signals, in order to avoid interferences.

The tester requires a pulse of at least 0.5 second. The outputs need approx. 5 mA, the outputs can be loaded with max. 0.5 A (max. 30 VDC).

Once all preparations have been made:

- Connect all plugs and ensure tight fit.

The modes of input and output signals can be found in the enclosed flow chart.

2. Serial interface.

2.1 Serial interface with register programming format

(see menu 3. SETUP PARAMETER command reference - remote control via serial interface).

2.2 Serial interface with Profibus format

(see menu 3. SETUP PARAMETER command reference - Profibus output format).

Connecting serial interface(s)

After completing the test, the up-to-dated measuring values can be output to a data terminal unit via the serial interfaces. The *Appendix* to these instructions contains a few *sample printouts*. The header appears on each new page. When switching the device off and on again, the successive number is automatically reset to 1.

The test parameters for the existing programs can be output in the menu **SET PARAMETER** (see 1.1 Data output Parameter).

The two serial interfaces of the device are:

- 9-pin Sub-D socket, serial, V24 RS232C Ser#1, X22
(see item 23 back view)
- 9-pin Sub-D socket, serial, V24 RS232C or Profibus Ser#2, X23
(see item 24 back view)
- Wire the plug connections by following the enclosed *plug assignment diagram*.

Transfer format: (factory setting)

115.200 baud, baud rate adjustable from 300 ... 460 800,
8 bit data, 1 stop bit, no parity, no protocol

Connecting the electric power supply

Connect the leak tester only to a main voltage of 100 ... 240 V, 50/60 Hz (without changeover) provided for this purpose.

The power consumption of the device is approx. 100 VA.

It is protected by a T2A / 250V IEC127-2 input fuse.

- Plug the power supply cable into the mains connection on the back of the unit.
- Connect the power supply cable to the mains supply network.

The tester is ready for operation and can be switched ON.

Switching the device ON and OFF



DANGER caused by electric current!

After connecting the device check that all cables are routed in such a way, that they cannot be buckled or squashed or damaged in any other way.

Only switch on the device after all connections have been made and checked for correct fit.

- Press key **I** on the front of the device to switch on.
The display light is switched on.
- Press key **0** on the front of the device to switch off.
The display light is switched off.

Initializing

Before starting operation all connections to peripheral equipment must be made and checked for tight fit.

- Switch on all peripheral equipment by following the corresponding instructions.
- Switch on the tester, see previous section.
The display is switched on and the device is initialized.



Dialog window during initialization of the device



Dialog window during initialization of the device with option Profibus

- Test devices with activated Profibus interface try to make a connection to the Profibus during the initialization.
The attempt to connect is indicated in the help bar.
- No connection to the Profibus leads to the message "connection failed" indicated in the help bar.
By pressing the key "ESC" the failed connection is acknowledged and the main menu is displayed.

The display

- Wait until the initialization has been completed and the **MAIN MENU** appears in the display.

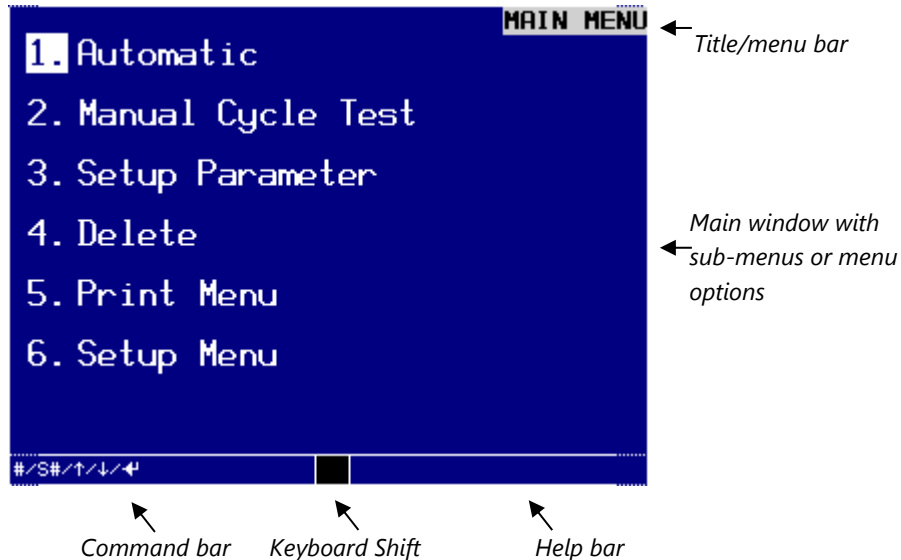

The main menu appears after the device has been initialized.

Title or menu bar

The name of the current dialog window or application always appears in the top right hand corner of the display.

Main window

In the main menu you will find the individual selectable sub-menus.

Command bar

The command bar shows the available keys to operate the current menu:

- # for alpha-numerical input
- ↑ to move the cursor up
- ↓ to move the cursor down
- ← to move the cursor to the left
- to move the cursor to the right
- ↵ to confirm an input or a selection by pressing the **ENTER**-key
- ESC to abort an action/to return to the previous menu
- PgUp to scroll on page back
- PgDn to scroll one page forward
- F1 function key
- F2 to start/enable a certain system function

Key symbol Operate the key switch

Keyboard Shift

The Keyboard Shift displays the selected input mode.

- blank = numeric input
- A = alphabetic input
- S = Shift activates the red marked key board functions.
- SA = capital letters.

Help bar

The help bar contains information about the selected process. When the cursor is in an input field, the info bar will show a brief description of the command or the possible input.

Working with the program

The device is interactively operated by means of a menu system, which always ends in a dialog window. The name of the current dialog window appears in inverted characters (white on black) in the title bar at the top right of the dialog window. The keys, which can be used for operation, are listed in the command bar at the bottom left. In the help bar at the bottom right you will find information to the possible entries for the parameter, on which the cursor is presently positioned.

You can select a menu option by either moving the cursor with the arrow keys, or by direct input of the cipher in front of the menu. Then confirm the selection by pressing the **ENTER**-key.

The program memorizes the settings made last in each dialog window. When you call up a dialog window again later, the cursor will be at the position that was changed last.

Using the write protection switch

The possible input in a dialog window depends on the position of the write protection switch on the tester. If the key switch is in vertical position or is pulled off, the device is in write protected viewing mode and you can only make a few changes concerning the selection and appearance of saved data.

When you turn the key to the right, you switch on the input mode, and you can change saved data or enter new data. In input mode the cursor jumps to the position that was changed last in the displayed dialog window.

You can always close a dialog window by pressing the **ESC**-key.

NOTE!



If you leave a dialog window in input mode, all entries previously made in the dialog will be lost.

If you have changed data in one of the dialog windows in input mode and turn the write protection switch to the left, i.e. locking, these data in the dialog window will be saved. The device acknowledges this saving process with a short audible signal.

Faulty or incorrectly entered data are automatically corrected by the program or replaced by standard parameters specified in the system configuration. In such a

The display

Using the write protection switch

case the user is informed about the changed or replaced data by a warning window.

Command reference

In this chapter you will find all commands and functions of the control software for the leak tester Leak Test 0065. The sequence follows the program structure, as shown in the table:

Program structure

Level 1	Level 2	Level 3	Level 4
Main menu	1. Automatic		
	2. Manual	1. Test	
		2. Pressurize (Flooding)	
	3. Setup	1. Parameter set	
		2. Date & Time	
		3. Serial Port(s)	1. Serial #1
			2. Serial #2 (option) or Profibus
			3. USB-Stick (option)
		4. Sequencer	
	4. Delete		
	5. Print Menu	1. View program status	
		2. Data collection	
		3. Operating data	
		4. Counter	
		5. Backup	
		6. Error counter status	
		7. Record)	
		8 Record Reference	
	6. Settings	1. Display	
	2. System parameters		
	3. Pressure control		
	4. System status		
	5. Options		

After you have started the device and the initialization process is completed, the display will show the **MAIN MENU** of the program or, if applicable, the previously set start menu.

Menu 1. AUTOMATIC

In **AUTOMATIC** mode the device is entirely controlled via the interface for machine control. This menu can only be used to monitor the sequence.



Dialog window MAIN MENU

Move the cursor to the first menu option 1. Automatic.

- Press the **ENTER**-key on the control panel.
The display shows the sub-menu **AUTOMATIC**.



Dialog window AUTOMATIC

Display the filling curve

In this mode you can toggle between the previous display and the filling curve display by simply pressing the arrow keys.

- Press the **SHIFT**-key and any **arrow** key on the control panel.
The filling curve display appears on the screen.



Filling curve display window

- Press the **ESC**-key on the control panel to return to the **MAIN MENU**.

Sequencer

The sequencer function can be globally activated or deactivated.
(see sequencer setup)

With the sequencer activated, the transmitted program number is interpreted as **Sequencer Number**. The transmitted program number must only be in the range from 1 to 10. Otherwise an error message 3 (**Program not available**) will be submitted.

With the **Start** signal the steps memorized under the selected sequencer number are successively processed.

Besides the program number the dialog window Automatic also shows the sequencer number **Seq: --** and the active step **Step: --**.

With the sequencer activated the number of passed cycles and the total number of cycles are displayed in between the measuring result and the measuring value unit.

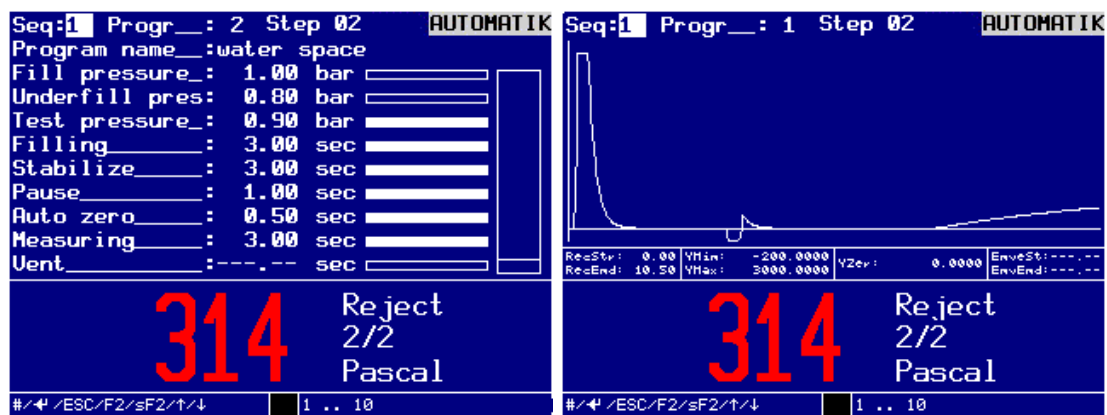

Dialog window AUTOMATIC SEQUENCER

If an error occurs in the sequence, the output error will be set and the complete test sequence aborted. The error must be acknowledged as specified for the corresponding machine interface. After a restart the complete test sequence is repeated.

If the input **Abort** is set, the entire test sequence will also be aborted. A restart will thus also start with the first activated test step.

In dependence on the setting of the switch **NIO=continue** for the corresponding test step, the sequence is aborted or continued in case of a measuring result unequal **I.O..**

At the end of any test step the output of the corresponding test result is set for a short time.

If none of the 10 possible steps is activated in the selected sequencer, the error message **no step activated** with error number 40 will be generated.

Automatic mode without leak simulation

In automatic mode the device is operated through a machine control interface. For more details please refer to chapter *Exchange of signals with the machine control*.

Automatic mode static test (flooding)

If the signal Static Test X21/4 is applied instead of the signal Start X21/2, the specimen will be exposed to the test pressure determined in the parameter set of the selected program. The specimen is kept pressurized, as long as the signal Static Test is applied.

Menu 2. MANUAL

The menu **2. MANUAL** serves the manual operation of the test device. All commands must be entered manually via the keypad.

Choose **MAIN MENU / 2. Manual** the **MANUAL MENU** is displayed. There are two sub-menus available:



Dialog window **MANUAL MENU**

- Test.
You can check manually with and without leak.
- Pressurize (flooding).
You can pressurize the specimen manually with test pressure.

1. Test

Confirm the selection **1. Test** by pressing the **ENTER**-key or **1**, an empty dialog window **MANUAL** will be displayed.

To launch the desired program:

- enter the number of the desired program (in this example: 1) into the top line and confirm the entry with the **ENTER**-key.

Testing without leak simulation

The dialog window **MANUAL** gives you the possibility to start a test without leak simulation.

- Press key **F2** to start the test **without leak simulation**.

NOTE!



If you selected the option **EnvelopCurveTolerances ON** in the dialog window **SETUP TEST PARAMETER SET**, the error message **REFERENCE CURVE MISSING** will be displayed when starting the first test.

For the initial testing of the device functions you should temporarily disable this option. The reference curve determination function is described later.

The test sequence can be easily followed by the horizontal progress bar. The current status of the test sequence is additionally displayed in the help bar.



Dialog window for manual testing

If you prefer the filling curve display:

- Press the **SHIFT**-key and any **arrow key**.
The display shows the test sequence in form of a curve.



Dialog window for filling curve representation of test

- If you want to return to the dialog window, press **SHIFT**-key and a **arrow key** again.

You can now exit the menu by pressing the **ESC**-key and call up and execute other functions of the device, without having to interrupt the test process. The test sequence is not interrupted, but continues in the background. The test result is displayed after the test sequence has finished.

If you want to abort the test:

- press the keys **SHIFT + ESC** in succession.
The test sequence is aborted, the up-to-date status of the test at the time of the abortion remains in the display.

1.1 Determination of a reference record

Connect a leak free original work piece to the tester.

Proceed as follows to determine the reference curve:

- enter the number of the desired program (in this example: 1) into the top line and confirm the entry with the **ENTER**-key.
- Turn the key switch clockwise to horizontal position (input mode ON).
- Press key **F2** to start the test without leak simulation.

You can follow the test sequence by the horizontal progress bar, the help bar additionally shows the corresponding actual status of the test sequence.



Dialog window for manual testing

Once the test is completed, the display will show the following message.

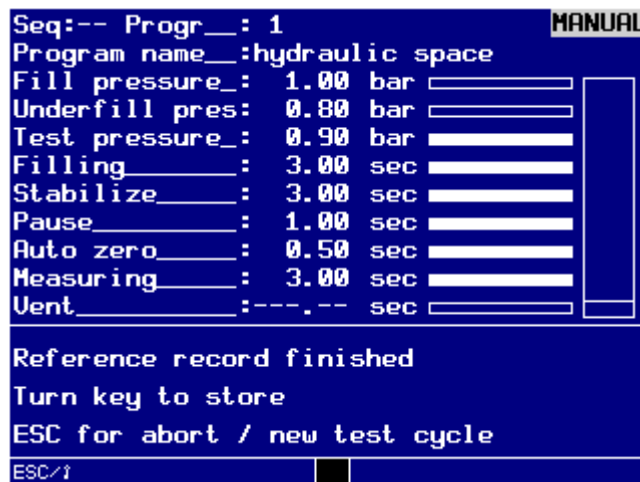

Dialog window manual test, determination of reference curve

- Turn the key switch anti-clockwise to vertical position to save the reference curve you have determined. An audible signal will sound and the determined data will be written to the RAM memory.
- Press ESC to determine a new reference curve. A new measurement will be executed.

1.1 Sequencer

The sequencer is available in automatic mode and in manual mode.

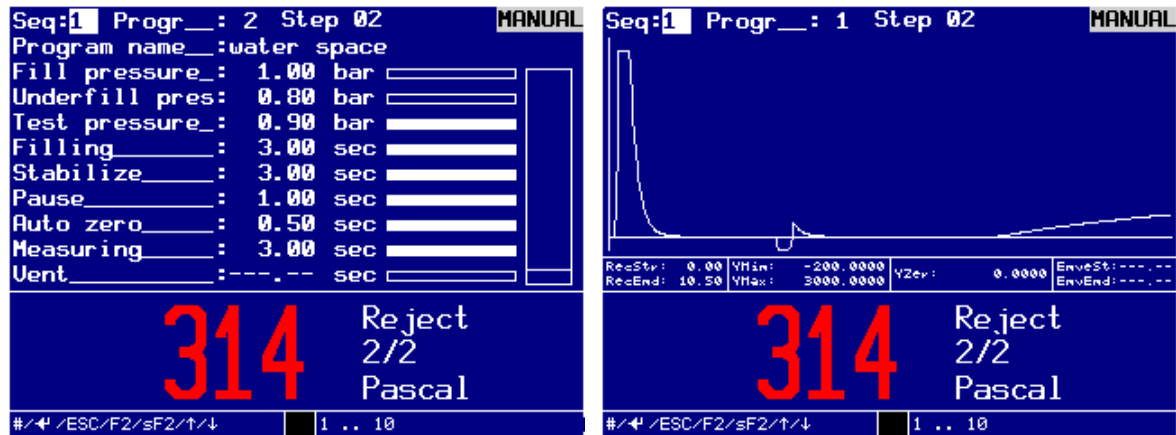

Dialog window MANUAL SEQUENCER

The number of the sequencer is always visible. There is a combined design used for sequencer number, program number and step number (Seq: -- / Progr: -- / Step: --).

Operating mode:

Sequencer deactivated:

The Sequence number is disabled and displayed as Seq: --.

Automatic mode:

The input field **Seq: --** and **Progr: --** are not editable.

Manual mode:

The input field **Seq: -** is not editable. The input field **Progr: --** is, as long as no test cycle was launched, editable. The input area is with 1 ... 99 indicated. If the entry is completed with **Enter**, if available, the related test program will be loaded and the parameters are presented at the display. Afterwards the test sequence can be started with **F2**.

It is **not necessary** to enter the program number by pressing the **Enter**-key.

You can also enter the program number key **F2**. In this case, the related test program will be loaded and the parameters are presented directly at the display and directly afterwards test sequence starts.

Sequencer enabled:

The input field **Seq: --** shows the Sequence number. The input field **Progr: -** is not editable.

Automatic mode:

The input fields **Seq: --** and **Progr: --** are not editable.

If the sequencer program is not available or if no test program is activated in the sequencer program, the input is not accepted and all variable image contents are set to **undefined**.

If an error occurs in the sequence, the output error will be set and the complete test sequence aborted. The error must be acknowledged as specified for the corresponding machine interface. After a restart the complete test sequence is repeated.

If the input **Abort** is set, the entire test sequence will also be aborted. A restart will thus also start with the first activated test step.

In dependence on the setting of the switch **NIO=continue** for the corresponding test step, the sequence is aborted or continued in case of a measuring result unequal **I.O..**

At the end of any test step the output of the corresponding test result is set for a short time.

If none of the 10 possible steps is activated in the selected sequencer, the error message **no step activated** with error number 40 will be generated.

2. Pressurize (Flooding)

This function is intended for visual leakage detection, for which the specimen is manually pressurized with the programmed test pressure.

The menu sequence **2. MANUAL/2. Pressurize** opens the dialog window **MANUAL PRESSURIZE**:

The image shows two overlapping terminal windows. The background window is titled 'MANUAL' and displays a menu with '1. Test' and '2. Pressurize'. The foreground window is titled 'MANUAL PRESSURIZE' and contains the following fields:

```
Program_____ : --
Date_____ : -----
Program name__ :
Workpiece_____ :
Operator_____ :
Test pressure_ : ---.-- bar
```

At the bottom of the foreground window, there is a status bar with the text '#/←/ESC' and '1 .. 99'. The background window has a status bar with '#/S#/↑/↓/←/→/ESC' and '1..2'.

Dialog window for manual pressurize

- Into the test field **Program**: enter the desired number and press the **ENTER**-key to confirm.
The dialog window with the desired program is displayed. You can check the programmed test pressure build-up by the horizontal progress bar.

The image shows the 'MANUAL PRESSURIZE' dialog window with the following data entered:

```
Program_____ : 1
Date_____ : 25012010
Program name__ : hydraulic space
Workpiece_____ : dosing system
Operator_____ : Mueller
Test pressure_ : 0.90 bar
```

At the bottom of the window, there is a status bar with the text '#/F2/sF2/ESC' and '0ff'.

Dialog window for manual pressurize

Testing without leak simulation

The dialog window **MANUAL PRESSURIZE** gives you the possibility to pressurize the test specimen without or, optionally with leak simulation.

- Press key **F2** to start pressurize without leak simulation.

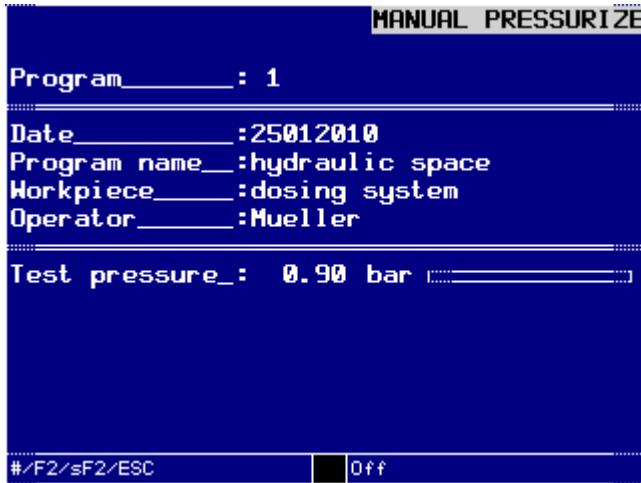

Dialog window **MANUAL PRESSURIZE**

You can follow the pressure build-up sequence by the horizontal progress bar, the help bar additionally shows the corresponding actual status of static test.

NOTE!



In the operation modes for automatic and semi-automatic testing, the duration of pressurizing is determined by application of the signal **PRESSURIZE ON**.

Menu 3. SETUP

In the **MAIN MENU** under **3. SETUP** you find the dialog window **SETUP**. This menu can be used to set up test programs, set date and time and set up the various interfaces.

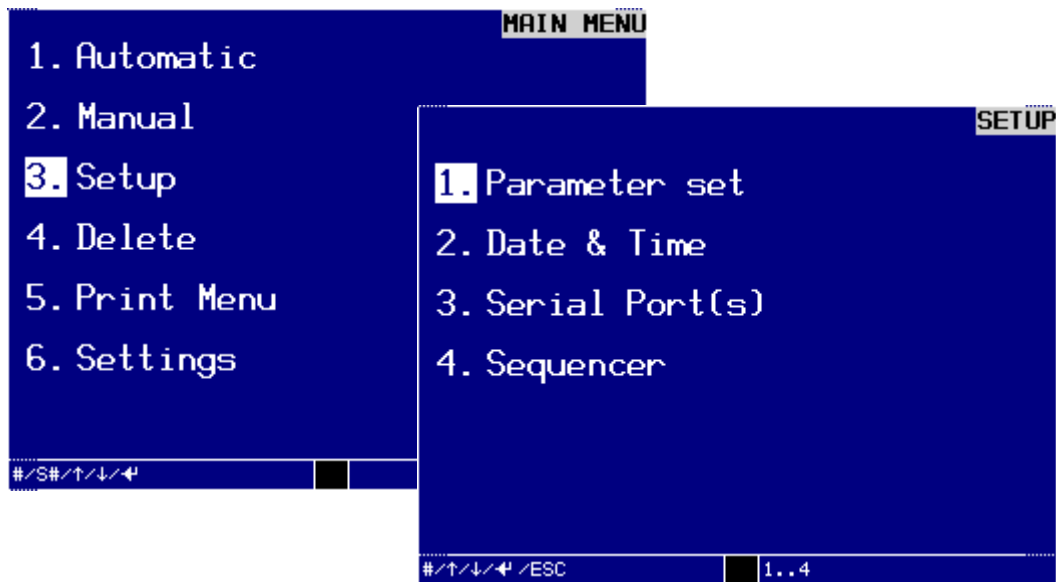

Dialog window *SETUP*

1. Set parameter (Test program)

If you confirm the selection **1. Parameter set** in the dialog window **SETUP** by pressing the **ENTER**-key, the following dialog window will open:

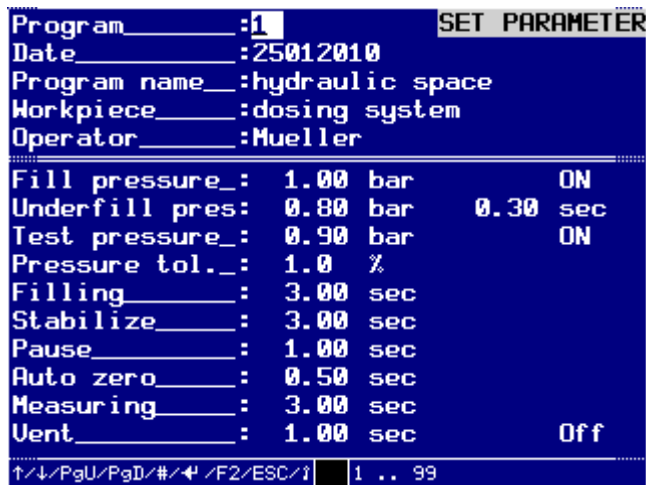

Dialog window *SET PARAMETER*

Creating or changing a test program

In order to be able to make entries in this dialog window, you must first switch the device to edit mode with the key switch:

- Turn key switch clockwise.
Write protection is disabled, entries can be made.
- Make all following entries and confirm these individually by pressing the **ENTER**-key. The help text depends on the version of the device.
The insertion point jumps to the next field.

Program:

Enter a number between 1 ... 99.

NOTE!



If you want to create a new program, please enter a program number that is not yet occupied.

If you want to edit a program that already exists, enter the corresponding number.

Program name:

maximum 23 characters (available)

Work piece:

maximum 23 characters (available)

Operator:

maximum 23 characters (available)

Fill pressure:

You may enter a value between 0.2 ... 6.00 bar, or accept the default value of 1.00 bar.

Fill pressure ON/OFF

You can switch the filling pressure to ON or OFF with the – and + keys. The default setting is ON.

Underfill pressure:

You can enter a value between 0.2 ... 6.00 bar or accept the default value of 0.80 bar.

NOTE!

Calculate the underfill pressure as in the following example:



Fill pressure $F = 2.10 \text{ bar/ü}$

Test pressure $P = 1.90 \text{ bar/ü}$

Underfill pressure = $P - (F - P) = 1.90 - (2.10 - 1.90) = 1.70 \text{ bar/ü}$

NOTE!

Change the default values for underfill time, pause time and tare time only after consulting the manufacturer.



Underfill time: 0.3 s, Pause time: 1.0 s and Tare time: 0.5 s.

Set the times so, that an open specimen connection will cause a rapid shut-down.

The underfill time must be in the range from 0.00 ... 10.0 seconds. It is within the stabilizing time and has no influence on the duration of the test cycle. Default value is 0.30 sec.

Test pressure:

The value should be 0.2 ... 6.00 bar.
Default value is 0.90 bar.

Pressure tolerance:

The value should be 0.5 ... 10.0 % and it is the tolerance of the pressure regulation in % of the end value.

Filling:

Enter the fill time in seconds from 0.10 ... 999.99 seconds.
Default value is 3.00 sec.

Stabilize:

Enter the stabilize time in seconds from 0.10 ... 999.99.
Default value is 3.00 sec.

NOTE!

Change the values for underfill time, pause time and tare time only after consulting the manufacturer. Accept the default values for the underfill time: 0.3 s, Pause time: 1.0 s and Tare time: 0.5 s.



In case of low test pressures (approx. <0.5 bar) or low volume specimen (approx. <100 ml) the pause and tare times may need to be shortened (possibly no test pressure in specimen). The times must be set in such a way, that an open specimen will trigger a rapid shut-down.

Pause:

Enter the pause time in seconds from 0.10 ... 999.99.
Default value is 1.00 sec.

Auto Zero:

Enter the auto zero time in seconds from 0.10 ... 999.99.
Default value is 0.50 sec.

Measuring:

Enter the measure time in seconds from 0.10 ... 999.99.
Default value is 3.00 sec.

Vent:

Enter the vent time in seconds from 0.10 ... 999.99.
Default value is 1.00 sec.

NOTE!



The entered vent time influences the output time for the result message after completing the measurement.

Vent ON/OFF

You can switch vent to ON or OFF with the – and + keys.
Default setting is OFF.

After these inputs and pressing the **SHIFT + PgDn** keys, or **SHIFT + PgUp** keys, the second page of the dialog **SET PARAMETER** is displayed:

```

SET PARAMETER
Unit_____ :Pascal
Fixture offset___ : 0 Pa
Volume multiplier:-.-----
Rework limit_____ : 100 Pascal ON
Reject limit_____ : 200 Pascal ON
Consec. reject no: 5
Protocol_____ :Ser #1

Record start_____ : 0.00 sec
Record end_____ : 3.00 sec
EnvelopeTolerance: 1.00 % Off
EnvelopeStart_____ : 0.00 sec
EnvelopeEnd_____ : 3.00 sec

↑/↓/PgU/PgD/#/←/→/F2/ESC/↑ | Pascal .. ml/min

```

Continuation of dialog window SET PARAMETER

Unit:

The unit for the measuring value can be selected with the – and + keys: Pascal, mbar, psi, mmWC, mmHg or ml/min.
Default setting is Pascal.

Fixture offset:

This value influences the zero point of the device. Depending on the direction of the entered value, the zero point is reduced in case of negative values and increased in case of positive values.

Enter the fixture offset from 0 ... 999 Pa.
Default value is 0 Pa.

Volume multiplier:

This value is for the calculation of the conversion of the measuring value to ml/min. The factor must be 0.0001 ... 9.9999. The default value is 1.0000.

To display the leak rate in ml/min the leak tester requires a volume multiplier. This volume multiplier can be calculated with the following formula:

$$\text{Volume multiplier} = \frac{\text{known leak rate (ml/min)}}{\text{measured value on measuring value display (Pa)}}$$

**NOTE!**

When parameters were changed, the conversion factor must be determined again.

Rework Limit:

The intervention limit for rework must be 1 ... 2000 mbar.
Default value is 100.

Rework ON/OFF

You can switch rework to ON or OFF with the – and + keys.
Default setting is ON.

Reject Limit:

The intervention limit for leaks must be 1 ... 2000 mbar.
Default value is 200.

Consecutive reject number:

Here you can specify from which number of test results **REJECT** in direct consecutive a fault is present. The limit for consecutive reject must be in the range from 0 ... 999.
Default value is 5.

**NOTE!**

Edit 0 disables this function.

Protocol:

With the keys – and + you can choose the output channel for the test results: OFF, Ser #1, Ser #2 (option), Ser #1 and Ser #2 (option):

Record start:

Enter the reference curve start point in seconds from 0.00 ... 999.99.
Default value is 0.00 sec.

The start point of the reference curve is the point in time from which the reference curve is recorded, after the leak test has been started.

Record end:

Enter the record end point in seconds from 0.10 ... 999.99.
Default value is 3.00 sec.

The end point of the record (reference curve) is the point in time at which recording of the record is stopped, after the leak test has been started.

EnvelopTolerance:

The value should be 0.5 ... 25.0 % and it is the tolerance of the permissible deviation from the stored reference curve in % of the end value.

EnvelopTolerance ON/OFF:

You can switch enveloping curve tolerance to ON or OFF with the – and + keys. Default setting is OFF.

EnvelopStart:

Enter the enveloping curve start point in seconds from 0.00 ... 999.99. Default value is 0.00 sec.

The start point of the enveloping curve is the point in time from which the deviation of the enveloping curve from the reference curve is recorded, after the leak test has been started.

EnvelopEnd:

Enter the enveloping curve end point in seconds from 0.10 ... 999.99. Default value is 3.00 sec.

The end point of the enveloping curve is the point in time at which the evaluation of the enveloping curve's deviation from the reference curve is stopped, after the leak test has been started.

Saving the test program

By pressing the keys **SHIFT + PgDn** keys, or **SHIFT + PgUp** you can view both menu pages again and make changes, which may be necessary. Once you have made all desired changes in this dialog window, you can save these data.

To do so:

- Turn the key switch anti-clockwise to vertical position. An audible signal will sound and the changed data will be written to the RAM memory.
- Pull off the write protection switch in vertical ON-position, to avoid undesired changes.

NOTE!

If you turn the key switch to vertical position while entries are still missing, an audible signal will sound and the display will show a warning with the list of the still undefined parameters, into which the device will automatically enter the standard values.

If you want to exit the menu without saving:

- Press the **ESC**-key. The first dialog window **SET PARAMETER** is displayed again.
- Press the **ESC**-key again, to return to the dialog window **SETUP**.

Checking the plausibility of inputs

Before the test parameters are written into the RAM memory, all entered parameters are subjected to a plausibility check:

Rework Limit < Reject Limit.

If the values do not meet the specifications, the program will adjust the corresponding parameters accordingly and shows this by inverse representation in the display. You may either correct the parameters, or accept them in the changed form.

1.1 Printout PARAMETER

Here you can decide whether the program parameters should be shown on the display or be printed out via an interface. Additionally you can select which program parameters should be displayed or printed out.

In the **MAIN MENU / 3. Setup** you will find the dialog menu **SETUP**.

In the Menü **SETUP / 1. Parameter set** you can select the program number. The program parameters will be shown in the display.

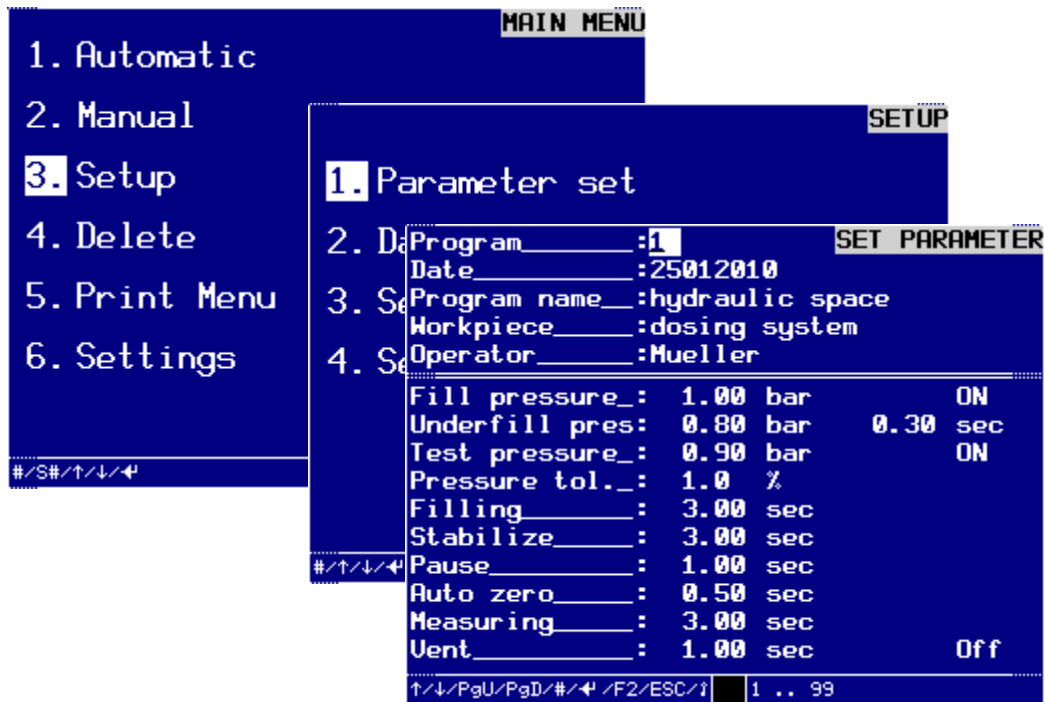

Dialog window SET PARAMETER

- Press key **F2** to activate the dialog window **PRINT DATA** for data transfer via interface.
On the display appears the window Print Data.

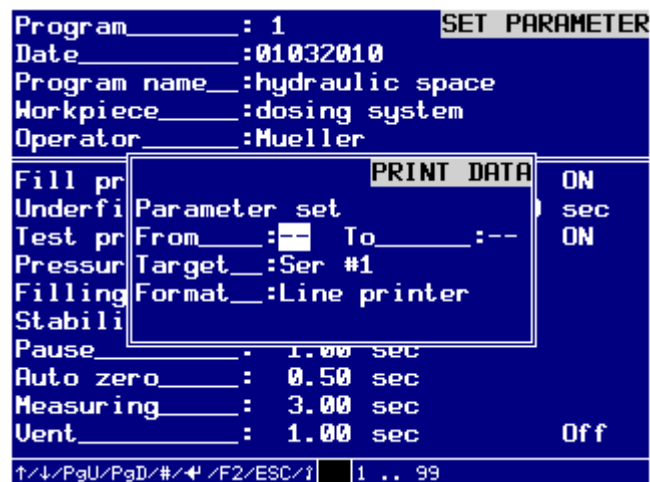

Set Parameter – Print Data

- from: / to:**
Enter the range of previous program parameter you want to output into the

text fields **from:** und **to:**, and confirm these individually with the **ENTER**-key. Possible entries range from 1 ... 99.

- **Target:**
Press the keys – and + to determine the desired **TARGET** for the data output:
You can select between:
Ser #1,
Ser #2,
USB-Stick.
Confirm the selection by pressing the **ENTER**-key.
- **Format:**
Press the keys – and + to determine the desired **FORMAT** for the data output:
You can select between:
LINE printer.
Confirm the selection by pressing the **ENTER**-key.
- You can output the selected program parameter through the selected interface by pressing the **F2**-key.
The message **Print data is active!** is display in the display.
- Press the **ESC**-key to exit the menu.

NOTE!

With a data output to a USB stick or external hard drive a file will be automatically generated. The file name consists of the serial number and the ending PAR.

e.g. 10100100.PAR.

If a file with same file name already exists, the file will be opened and the data append to the file.



1.2 Copying an existing test program

If you would like to copy an existing test program, you must save it under a different program number. To do so

- Make sure that the key switch is in vertical write protection position.
- Select the program to be copied from the dialog window **TEST PROGRAMS** by Edit the number (1 ... 99) into the field Program and confirm the selection by pressing the **ENTER**-key.
The desired test program is displayed.

```

Program_____ :1_____ SET PARAMETER
Date_____ :25012010
Program name__ :hydraulic space
Workpiece____ :dosing system
Operator_____ :Mueller
-----
Fill pressure_ : 1.00 bar      ON
Underfill pres: 0.80 bar      0.30 sec
Test pressure_ : 0.90 bar      ON
Pressure tol._ : 1.0 %
Filling_____ : 3.00 sec
Stabilize____ : 3.00 sec
Pause_____ : 1.00 sec
Auto zero____ : 0.50 sec
Measuring____ : 3.00 sec
Vent_____ : 1.00 sec      Off
-----
↑/↓/PgU/PgD/#/←/→/F2/ESC/1 1 .. 99

```

Test program to be copied

- Turn the key switch clockwise to input mode.
- Enter the new program number (1 ...99) into the "Program" field.
- Turn the key switch anti-clockwise to switch the write protection ON.
An audible signal will sound and the device saves the changed data to the RAM memory.

```

Program_____ :2_____ SET PARAMETER
Date_____ :25012010
Program name__ :hydraulic space
Workpiece____ :dosing system
Operator_____ :Mueller
-----
Fill pressure_ : 1.00 bar      ON
Underfill pres: 0.80 bar      0.30 sec
Test pressure_ : 0.90 bar      ON
Pressure tol._ : 1.0 %
Filling_____ : 3.00 sec
Stabilize____ : 3.00 sec
Pause_____ : 1.00 sec
Auto zero____ : 0.50 sec
Measuring____ : 3.00 sec
Vent_____ : 1.00 sec      Off
-----
↑/↓/PgU/PgD/#/←/→/F2/ESC/1 1 .. 99

```

Copied test program

- Press the **ESC**-key to exit the menu.

2. Date & Time.

In the dialog window **SETUP DATE & TIME** you can set or change data and time

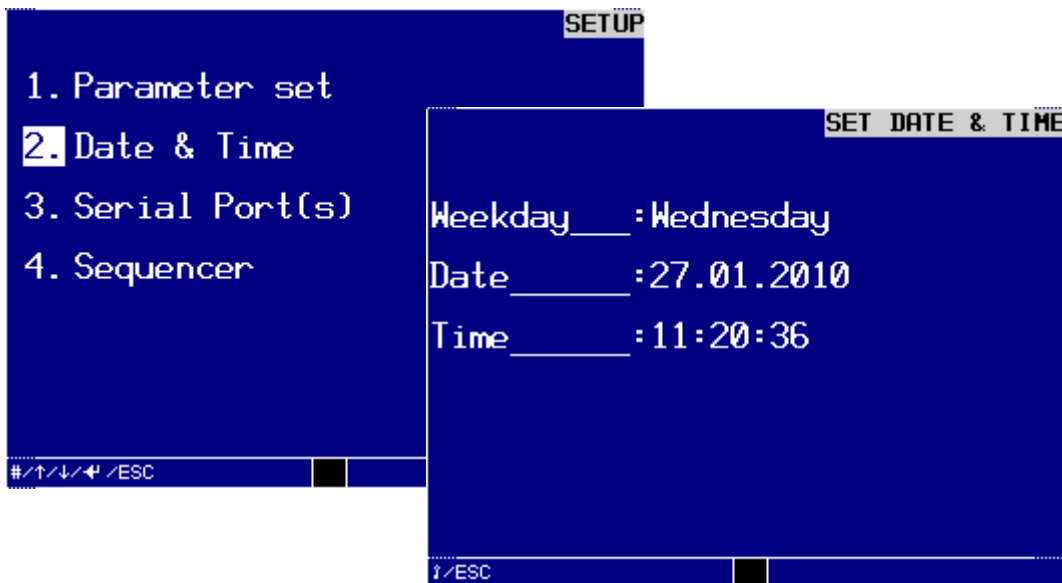

Dialog window *SETUP DATE & TIME*

- Turn the key switch clockwise to input mode, make the following entries and confirm each of them by pressing the **ENTER**-key:

Week day:

You can select the week day with the keys – or +.

Date:

Enter the day from 1 ... 31 using the numerical keys.

Enter the month from 1 ... 12 using the numerical keys.

Enter the year as a four-digit numerical value (e.g. 2010).

Time:

Enter the hour from 0 ... 23 using the numerical keys.

Enter the minutes from 0 ... 59 using the numerical keys.

Enter the seconds from 0 ... 59 using the numerical keys.

- Make sure that you have also confirmed the last entry for the seconds with the **ENTER**-key.
- Turn the key switch back to write protection ON.
An audible signal will sound and the device saves the changed data to the RAM memory.
- Press the **ESC**-key to exit the menu.

3. Serial ports

In the dialog window **SET SERIAL PORTS** you can set up or change interface(s). The interface **Ser #1** is available as standard. The interfaces **Ser # 2 ... USB-Stick** are optional.

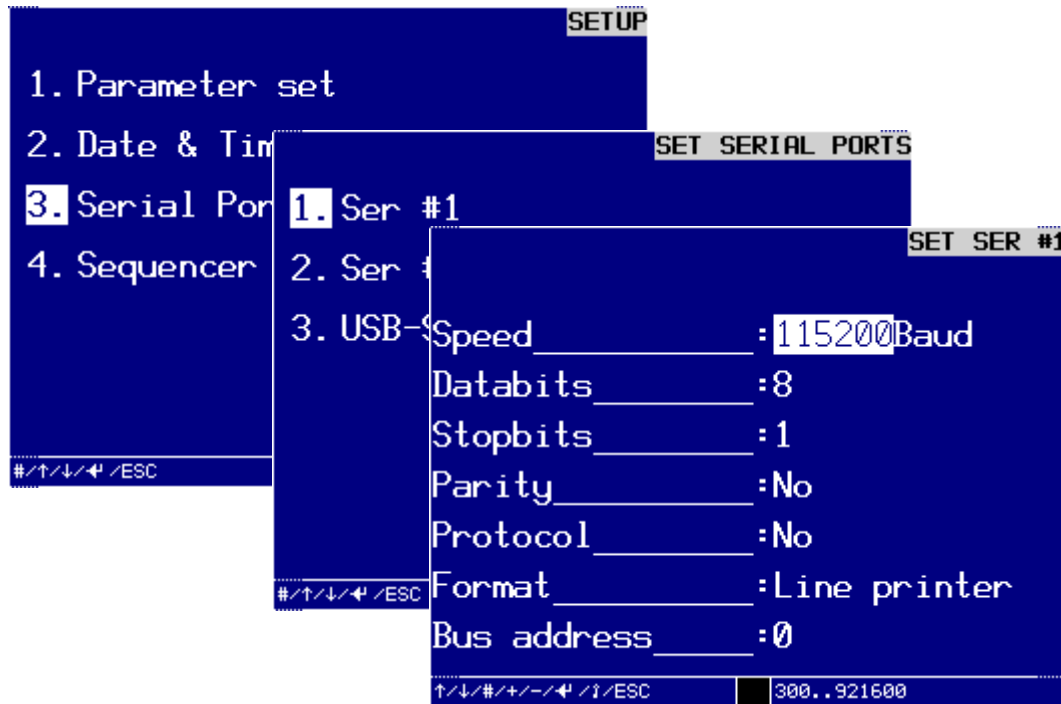

Dialog window SET SER #1

Output format line printer

Setting up an interface for a line printer

This section uses the interface **SER #1** as an example for setting up the output format for a line printer.

- Turn key switch clockwise.
Write protection is disabled, entries can be made.
- Make all following entries and confirm these individually by pressing the **ENTER**-key. The cursor jumps to the next field.

Speed:

You can select the transfer speed with the keys – and +.

Data bits:

You can use the keys – and + to select the number (7 or 8) of data bits.

Stop bits:

You can use the keys – and + to select the number (1 or 2) of stop bits.

Parity:

You can use the keys – and + to establish the type of parity check. The following are available to choose from: Without, Even, Uneven.

Protocol:

You can specify the transfer protocol with the keys – and +. The following are available to choose from: Without, XonXoff, RtsCts.

Format:

You can specify the transfer format with the keys – and +. The following are available to choose from: Line printer, File 01, File 02, Record and optional special formats, such as REGISTER, REGISTER+TO, REGISTER+TO+CS.

NOTE!

The output format **File** is a simple possibility for the processing of measuring results on a PC. This will only output the measuring results of the currently running test.

The following sections contain further information to the individual interface formats.

Once you have made and checked all entries, you can save these data.

- Turn the key switch back to the vertical write protection position. An audible signal will sound and the device saves the changed data to the RAM memory. The interface has been setup for the line printer output format.
- Press the **ESC**-key to exit the menu.

NOTE!

The interface type is determined by the hardware and cannot be changed through the program.

Output format File01

Set up / change the interface for format File 01 for data output to a PC.

Using the interface **SER #1** as an example, this section explains how to set up the output format for the output of File01 and File02 and which data will be output by the test device.

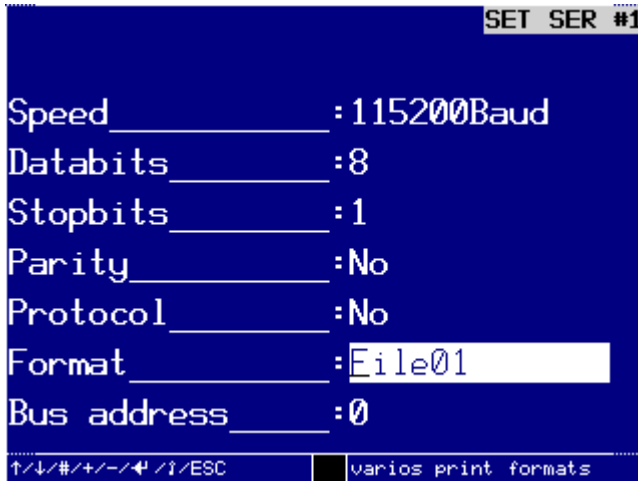

Setting up an interface for the output of measuring data to a PC

In order to set up an interface for the output of measuring data to a PC, you should select the **Format: File01** or **File02**.

These two output files differ by the volume of measuring data.

The measuring data of File01

In output format **File01** contains 8 measuring results in numerical format, each divided by a semicolon. Example of a measuring result:

00000001;	01;	01022004;	152621;	000000;	01;	01;	00
SerNo;	Pg;	DyMtYear;	HrMnSc;	Measva;	Unt;	Rs;	Er; ...
							Error number with 2 digits
							Result with 2 digits
							Unit with 2 digits
							Measuring value with 6 digits
							Hour Minute Second with 6 digits
							Day Month Year with 8 digits
							Program number with 2 digits
							Successive number with 8 digits

Serial number:

The serial number consists of 8 digits and starts with 00000001 when the device is switched on. Once the counter has reached 99999999, it will automatically restart at 00000001.

Program number:

The number of the executed test program in the range from 01 ... 99.

Day Month Year:

The date of testing consists of 8 digits: 2 digits for the day, 2 digits for the months, 4 digits for the year.

Hour Minute Second:

The time of testing consists of 6 digits. 2 digits each for hour, minute and second.

Measuring value:

The measured value with floating point representation matches the chosen unit. The output width is always 6 digits. Error messages or the measuring result "Coarse Leak" are represented by 6 minus dashes.

Unit:

The two-digit numerical value specifies the unit of the executed test program:

01 = Pa / ml/min

02 = mbar / ml/h

03 = PSI / l/min

04 = mmWC / l/h

05 = mmHg / m³/min

06 = ml/min / m³/h or %

Result:

The two-digit numerical value specifies the measuring result of the executed test program:

01 = I.O. / I.O.

02 = Rework 1 / LT

03 = Leak / UT

06 = Leak / Coarse Leak (Major leak)

-- = Error messages are identified by 2 minus dashes.

Error number:

The two-digit numerical value specifies the type of the error of the executed test program that has occurred:

00	No Error	01	No operating pressure
02	Memory card missing	03	Program missing
04	Transmitter defective	05	Pressure switch S2 defective
06	Pressure switch S3 defective	07	Pressure not adjustable
08	No pressure in test system	09	No pressure in specimen
10	Coarse leak in reference volume	11	Pressure after filling valve
12	Shut-off valve open	13	Leak in reference volume
14	Series fault	15	Temperature value too low
16	not available	17	Overflow absolute pressure transducer
18	Limit contact "Leak" cannot be reached	19	Pressure increases after shutting off
20	Apex not reached	21	Differential pressure switch not off
22	Differential pressure switch not on	23	Filling pressure too low
24	Filling pressure too high	25	Test pressure too low
26	Test pressure too high	27	Pressure system not adjustable
28	Rated pressure out of range	29	Incorrect pre-selection
30	Hook 1 missing (optional)	31	Hook 2 missing (optional)
32	Hooks 1 +2 missing (optional)	33	Pressure switch S4 defective
34	Pressure correction value too high	35	Pressure in reference volume too low or flow-in time too short
36	Pressure in reference volume too high	37	Test pressure in sequence too low
38	Test pressure in sequence too high		

The output of some of the error numbers depends on device type or options. If the number of the error is $\neq 0$, minus symbols will be displayed for measuring value and measuring result.

If a numerical value cannot be displayed in the defined output format, the field will be output with "↑↑↑↑↑↑" (Code 18H) when exceeded, or with "↓↓↓↓↓↓↓" (Code 19H) when fallen short of. The individual positions are separated by semi-colon. The data set is closed with a carriage return and a line feed (CR+LF).

Examples:

No Leak	00000001;01;01022000;152621;000000;01;01;00
Gross leak	00000002;01;01022000;152637;-----;01;04;00
Fault	00000003;01;01022000;152718;-----;01; --;25

Output format File02

```

SET SER #1

Speed_____ : 115200Baud
Databits_____ : 8
Stopbits_____ : 1
Parity_____ : No
Protocol_____ : No
Format_____ : File02
Bus address_____ : 0

↑/↓/#/+/-/←/→/ESC   varios print formats

```

Setting the output format File02

The measuring data of File02

If you choose the format **File02** for the data output, five more measuring data will be output in addition to the measuring data of format File01, i.e. a total of 13, which are each separated by semicolon.

Example of a measuring result:

0000001;01;24022002;152621;000000;01;01;00;1,00;3,00;1,000000;50;100
(here NO LEAK)

SerNo;	Pg;	DyMtYear;	HrMnSc;	Measva;	Unt;	Rs;	Er; ...
							Error-No. with 2 digits
							Result with 2 digits
							Unit with 2 digits
							Measuring value with 6 digits
							Hour Minute Second with 6 digits
							Day Month Year with 8 digits
							Program number with 2 digits
							Successive number with 8 digits

Continued

... Test pressure;	Measuring time;	Volume factor;	Rework;	Leak
				Leak with 6 digits
			Volume factor with 9 or 6 digits	Rework with 6 digits
		Measuring time with 6 digits		
Test pressure with 6 digits				

In addition to the measuring data in format **Datei01** format **Datei02** will also provide the following data:

Test pressure:

Specifies the test pressure for the test with 6 digit. The output width is always 6 digits. The unit for the test pressure is bar/ü.

Measuring time:

Shows the entered measuring time in a structured representation. The unit for the measuring time is seconds.

Volume multiplier:

Shows the volume multiplier, used to calculate the measuring values, in a structured representation. The output width is always 9 or 6 digits.

Rework:

Specifies the limit contact for rework in the adapted structured representation. The output width is always 6 digits.

Reject:

Specifies the limit contact for leak in the adapted structured representation. The output width is always 6 digits.

Examples for the output of measuring data in the format File02.

Accept

```
00000001;01;24022002;152621;000000;01;01;00;1,00:3,00;1,0000000;50;100
```

Gross leak (major leak)

```
00000002;01;24022002;152637;-----;01;04;00;1,00:3,00;1,0000000;50;100
```

Error

```
00000003;01;24022002;152718;-----;01; --;25;1,00:3,00;1,0000000;50;100
```

3.1 Output format Profibus

Setting up the serial interface SER#2 for Profibus (optional)

If you would like to set up the serial interface SER #2 for Profibus, you must call up the dialog window SET SER #2:

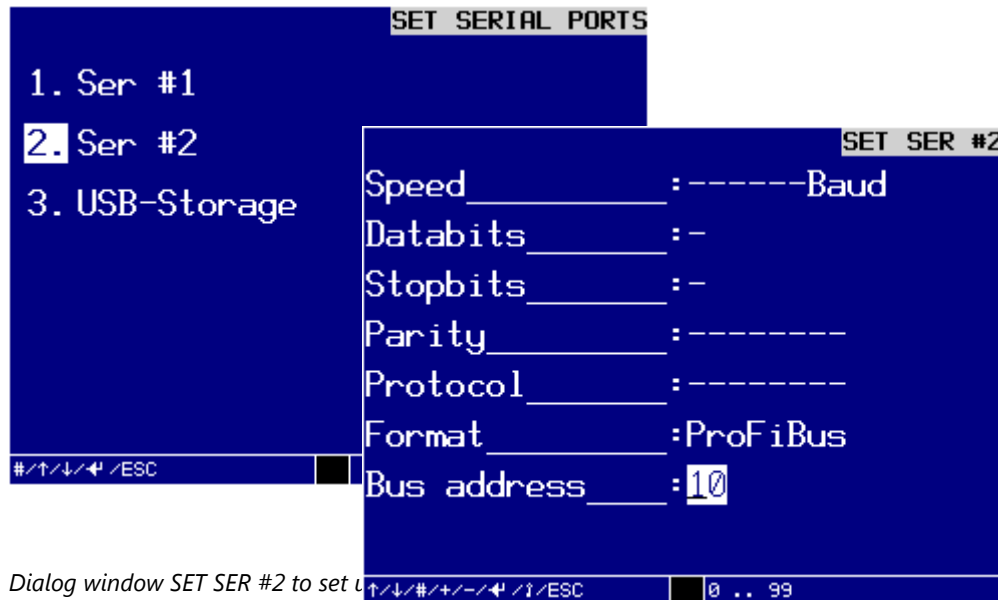

Dialog window SET SER #2 to set u

NOTE!

Make sure that the hardware for Profibus is installed



View:

6. SETTINGS\2.SYSTEM PARAMETER\SET SER #2:
RS232 57600 8 1 None XON/XOFF Profbus 10

In the dialog window SETUP SER #2:

Format:

You can specify the transfer format with the keys – and +. The following are available to choose from: Line printer, File 01, File 02, Profibus, Record and optional special formats, such as REGISTER, REGISTER+TO, REGISTER+TO+CS.

Speed:	9600 ... 115200 Baud
Data bits:	8
Stop bits:	1
Parity:	None
Protocol:	None
Format:	Profibus
Bus address:	0 ... 99

The Profibus inputs and outputs

If the Profibus is activated, it will take over the following inputs/outputs:

Type	Byte/Bit	Description		
		3925-0065 LEAK	3925-0150 FLOW	3925-0350 VOLUME
Input	1.0	Internal reserved		
Input	1.1	Internal reserved		
Input	1.2	Internal reserved		
Input	1.3	Internal reserved		
Input	1.4	Internal reserved		
Input	1.5	Internal reserved		
Input	1.6	Internal reserved		
Input	1.7	Internal reserved		
Input	2 . 0	Machine ready		
Input	2 . 1	Start		
Input	2 . 2	Not used	Reserve	Reserve
Input	2 . 3	Static test (Flooding)		Reserve
Input	2 . 4	Abort		
Input	2 . 5	Automatic		
Input	2 . 6	Reserve		
Input	2 . 7	Reserve		
Input	3 . 0	BCD 01 (Program selection)		
Input	3 . 1	BCD 02 (Program selection)		
Input	3 . 2	BCD 04 (Program selection)		
Input	3 . 3	BCD 08 (Program selection)		
Input	3 . 4	BCD 10 (Program selection)		
Input	3 . 5	BCD 20 (Program selection)		
Input	3 . 6	BCD 40 (Program selection)		
Input	3 . 7	BCD 80 (Program selection)		
Input	4.0	External reserve		
Input	4.1	External reserve		
Input	4.2	External reserve		
Input	4.3	External reserve		
Input	4.4	External reserve		
Input	4.5	External reserve		
Input	4.6	External reserve		
Input	4.7	External reserve		

		Description		
Type	Byte/Bit	3925-0065 LEAK	3925-0150 FLOW	3925-0350 VOLUME
	5.0	Not used		
	5.1	Not used		
	5.2	Not used		
	5.3	Not used		
	5.4	Not used		
	5.5	Not used		
	5.6	Not used		
	5.7	Not used		
	6.0	Not used		
	6.1	Not used		
	6.2	Not used		
	6.3	Not used		
	6.4	Not used		
	6.5	Not used		
	6.6	Not used		
	6.7	Not used		
Output	1.0	Internal reserved		
Output	1.1	Internal reserved		
Output	1.2	Internal reserved		
Output	1.3	Internal reserved		
Output	1.4	Internal reserved		
Output	1.5	Internal reserved		
Output	1.6	Internal reserved		
Output	1.7	Internal reserved		
	2.0	Not used		
	2.1	Not used		
	2.2	Not used		
	2.3	Not used		
	2.4	Not used		
	2.5	Not used		
	2.6	Not used		
	2.7	Not used		

		Description		
Type	Byte/Bit	3925-0065 LEAK	3925-0150 FLOW	3925-0350 VOLUME
Output	3.0	External reserved		
Output	3.1	External reserved		
Output	3.2	External reserved		
Output	3.3	External reserved		
Output	3.4	External reserved		
Output	3.5	External reserved		
Output	3.6	External reserved		
Output	3.7	External reserved		
	4.0	External reserve		
	4.1	External reserve		
	4.2	External reserve		
	4.3	External reserve		
	4.4	External reserve		
	4.5	External reserve		
	4.6	External reserve		
	4.7	External reserve		
	5.0	Not used		
	5.1	Not used		
	5.2	Not used		
	5.3	Not used		
	5.4	Not used		
	5.5	Not used		
	5.6	Not used		
	5.7	Not used		
Output	6 . 0	Ready for operation		
Output	6 . 1	Fault		
Output	6 . 2	Ready for test		O.K.
Output	6 . 3	Rework / LT		Ready for test
Output	6 . 4	Reject / UT		LT (Min)
Output	6 . 5	No leak / O.K.		Reserve
Output	6 . 6	Enveloping curve Filling n.o.k. (optional)		Measuring active
Output	6 . 7	Measuring active		UT (Max)

		Description		
Type	Byte/Bit	3925-0065 LEAK	3925-0150 FLOW	3925-0350 VOLUME
Output	7 . 0 ... 7	Measuring value identifier		
Output	8 . 0 ... 7	1. Digit measuring value		
Output	9 . 0 ... 7	2. Digit measuring value		
Output	10 . 0 ... 7	3. Digit measuring value		
Output	11 . 0 ... 7	4. Digit measuring value		
Output	12 . 0 ... 7	5. Digit measuring value		
Output	13 . 0 ... 7	6. Digit measuring value		
Output	14 . 0 ... 7	7. Digit measuring value		
Output	15 – 0 ... 7	7. Digit measuring value		
Output	16 . 0 ... 7	9. Digit measuring value		
Output	17 . 0 ... 7	10. Digit measuring value		
Output	18 . 0 ... 7	11. Digit measuring value		
Output	19 . 0 ... 7	12. Digit measuring value		
Output	20 . 0 ... 7	13. Digit measuring value		
Output	21 . 0 ... 7	14. Digit measuring value		
Output	22 . 0 ... 7	15. Digit measuring value		
Output	23 . 0 ... 7	16. Digit measuring value		

The following identifier are possible:

ASCII „0“ = Measuring value invalid
 ASCII „1“ = Measuring value in measuring range 1
 ASCII „2“ = Measuring value in Measuring range 2
 ASCII „3“ = Measuring value in Measuring range 3
 ASCII „4“ = Measuring value in Measuring range 4
 ASCII „5“ = Measuring value in Measuring range 5
 ASCII „6“ = Measuring value in Measuring range 6
 ASCII „G“ = Gross leak
 ASCII „H“ = Envelop curve leaving
 ASCII „F“ = Error

The measuring value occupies 17 output bytes on the Profibus starting from the 7th output byte. All data outputs take place in the ASCII format.

For devices with Profibus you require the file PLC07v100.GSD for configuring the Profibus Master, this file is delivered on a separate CD.

3.2 Output format Profinet

Setting up the serial interface SER#2 for Profinet (optional)

If you would like to set up the serial interface SER #2 for Profinet, you must call up the dialog window SET SER #2:

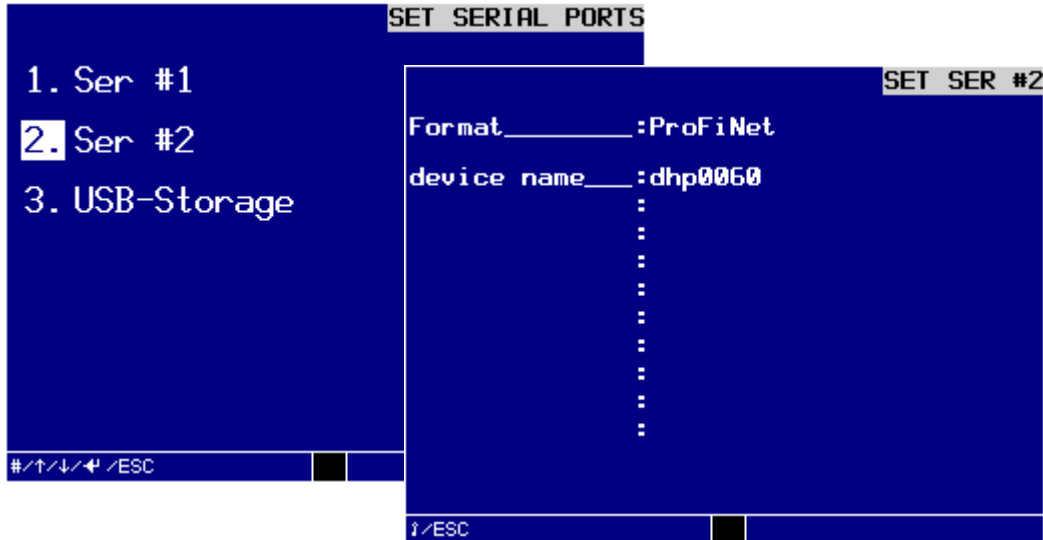

Dialog window SET SER #2 to set up for Profinet

Profinet-Functions

The Profinet module supports a maximum data rate of 128 byte input and 128 byte output data as well as all baud rates from 9.6 kbit / s to 12 Mbps. Baud rate detection is performed automatically.

The Profinet station address can be accessed via the menu

3. SETUP \ 3. SET SERIAL PORTS \ 2. SER #2

Make the following settings in the dialog window SETUP SER #2:

Format: Profinet (not editable)

Device name: dhp0065



NOTE!

The interface format is defined by the hardware and can not be changed via the program.

The test device with Profinet interface has 6 input bytes and 17 output bytes.

The breakdown is as follows.

The naming conventions of Profinet must be observed.

The Profinet inputs and outputs

If the Profinet is activated, it will take over the following inputs/outputs:

Type	Byte/Bit	Description		
		3925-0065 LEAK	3925-0160 FLOW	3925-0360 VOLUME
Input	1.0	Internal reserved		
Input	1.1	Internal reserved		
Input	1.2	Internal reserved		
Input	1.3	Internal reserved		
Input	1.4	Internal reserved		
Input	1.5	Internal reserved		
Input	1.6	Internal reserved		
Input	1.7	Internal reserved		
Input	2 . 0	Machine ready		
Input	2 . 1	Start		
Input	2 . 2	Not used	Reserve	Reserve
Input	2 . 3	Static test (Flooding)		Reserve
Input	2 . 4	Abort		
Input	2 . 5	Automatic		
Input	2 . 6	Reserve		
Input	2 . 7	Reserve		
Input	3 . 0	BCD 01 (Program selection)		
Input	3 . 1	BCD 02 (Program selection)		
Input	3 . 2	BCD 04 (Program selection)		
Input	3 . 3	BCD 08 (Program selection)		
Input	3 . 4	BCD 10 (Program selection)		
Input	3 . 5	BCD 20 (Program selection)		
Input	3 . 6	BCD 40 (Program selection)		
Input	3 . 7	BCD 80 (Program selection)		
Input	4.0	External reserve		
Input	4.1	External reserve		
Input	4.2	External reserve		
Input	4.3	External reserve		
Input	4.4	External reserve		
Input	4.5	External reserve		
Input	4.6	External reserve		
Input	4.7	External reserve		

		Description		
Type	Byte/Bit	3925-0065 LEAK	3925-0160 FLOW	3925-0360 VOLUME
	5.0	Not used		
	5.1	Not used		
	5.2	Not used		
	5.3	Not used		
	5.4	Not used		
	5.5	Not used		
	5.6	Not used		
	5.7	Not used		
	6.0	Not used		
	6.1	Not used		
	6.2	Not used		
	6.3	Not used		
	6.4	Not used		
	6.5	Not used		
	6.6	Not used		
	6.7	Not used		
Output	1.0	Internal reserved		
Output	1.1	Internal reserved		
Output	1.2	Internal reserved		
Output	1.3	Internal reserved		
Output	1.4	Internal reserved		
Output	1.5	Internal reserved		
Output	1.6	Internal reserved		
Output	1.7	Internal reserved		
	2.0	Not used		
	2.1	Not used		
	2.2	Not used		
	2.3	Not used		
	2.4	Not used		
	2.5	Not used		
	2.6	Not used		
	2.7	Not used		

		Description		
Type	Byte/Bit	3925-0065 LEAK	3925-0160 FLOW	3925-0360 VOLUME
Output	3.0	External reserved		
Output	3.1	External reserved		
Output	3.2	External reserved		
Output	3.3	External reserved		
Output	3.4	External reserved		
Output	3.5	External reserved		
Output	3.6	External reserved		
Output	3.7	External reserved		
	4.0	External reserve		
	4.1	External reserve		
	4.2	External reserve		
	4.3	External reserve		
	4.4	External reserve		
	4.5	External reserve		
	4.6	External reserve		
	4.7	External reserve		
	5.0	Not used		
	5.1	Not used		
	5.2	Not used		
	5.3	Not used		
	5.4	Not used		
	5.5	Not used		
	5.6	Not used		
	5.7	Not used		
Output	6 . 0	Ready for operation		
Output	6 . 1	Fault		
Output	6 . 2	Ready for test		O.K.
Output	6 . 3	Rework / LT		Ready for test
Output	6 . 4	Reject / UT		LT (Min)
Output	6 . 5	No leak / O.K.		Reserve
Output	6 . 6	Enveloping curve Filling n.o.k. (optional)		Measuring active
Output	6 . 7	Measuring active		UT (Max)

		Description		
Type	Byte/Bit	3925-0065 LEAK	3925-0160 FLOW	3925-0360 VOLUME
Output	7 . 0 ... 7	Measuring value identifier		
Output	8 . 0 ... 7	1. Digit measuring value		
Output	9 . 0 ... 7	2. Digit measuring value		
Output	10 . 0 ... 7	3. Digit measuring value		
Output	11 . 0 ... 7	4. Digit measuring value		
Output	12 . 0 ... 7	5. Digit measuring value		
Output	13 . 0 ... 7	6. Digit measuring value		
Output	14 . 0 ... 7	7. Digit measuring value		
Output	15 – 0 ... 7	7. Digit measuring value		
Output	16 . 0 ... 7	9. Digit measuring value		
Output	17 . 0 ... 7	10. Digit measuring value		
Output	18 . 0 ... 7	11. Digit measuring value		
Output	19 . 0 ... 7	12. Digit measuring value		
Output	20 . 0 ... 7	13. Digit measuring value		
Output	21 . 0 ... 7	14. Digit measuring value		
Output	22 . 0 ... 7	15. Digit measuring value		
Output	23 . 0 ... 7	16. Digit measuring value		

The following identifier are possible:

ASCII „0“ = Measuring value invalid
 ASCII „1“ = Measuring value in measuring range 1
 ASCII „2“ = Measuring value in Measuring range 2
 ASCII „3“ = Measuring value in Measuring range 3
 ASCII „4“ = Measuring value in Measuring range 4
 ASCII „5“ = Measuring value in Measuring range 5
 ASCII „6“ = Measuring value in Measuring range 6
 ASCII „G“ = Gross leak
 ASCII „H“ = Envelop curve leaving
 ASCII „F“ = Error

The measuring value occupies 17 output bytes on the Profinet starting from the 7th output byte. All data outputs take place in the ASCII format.

For devices with Profinet you require the GSDML-file for configuring the Profinet Master, this file is delivered on a separate USB-Stick.

Remote control via serial interface

Setting up or changing the interface for remote controlling of the device

This section uses the interface **SER #1** as an example for setting up the output format REGISTER or REGISTER+TO or REGISTER+TO+CS.

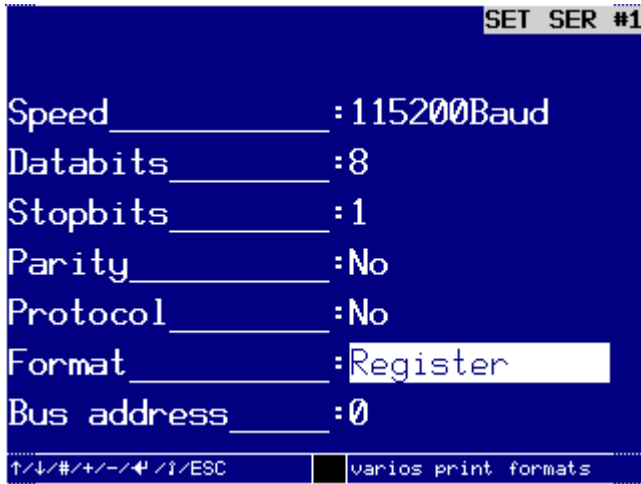

Dialog windows for setting up an interface for a special format

In order to set up an interface for the output of data to a PC in a special format, you should select the **Format: REGISTER** or **REGISTER+TO** or **REGISTER+TO+CS**.

These three output formats are special formats and serve the remote controlling of the tester via the serial interface. For remote controlling purposes the user is provided with a powerful set of commands.

Protocol for the complete control for all functions and parameters for the test device. The following information describes the functions in detail:

List of commands in alphabetical order

Command	Function	Access
AINnnn	Analog input (Analog INput)	Read
AOUNnn	Analog output (Analog OUtput)	Read
DINnnn	Digital input (Digital INput)	Read/partially write
DOUNnn	Digital output (Digital OUtput)	Read
FILnnn	Filling curve (FILLing curve)	Read
HSPnnn	Hardware system parameter (Hardware SystemParameter)	Read
PVRnnn,nnn	Test program variable (Program VaRiables)	Read/write
REFnnn	Reference curve (REFerence curve)	Read/write
RSVnnn	Result storing variable (ResultStore Variables)	Read
RVRnnn	Result variable (Result VaRiables)	Read
SPVnnn,nnn	Sequencer parameter variables (Sequencer Parameter Variables)	Read/write
SSPnnn	Program specific parameter (Software SystemParameter)	Read
STAnnn	Status variable (STAtus variables)	Read

Structure of commands

Syntax:

For the query of values:

RegisterName<(Start)Indize>[[-<EndIndize>]][:<Indize>;<Indize>;...][:CS]<CR>

For the setting of values:

RegisterName<Indize>=<Wert>[:CS]<CR>

or

RegisterName<StartIndize>-<EndIndize>=<Wert>;<Wert>;<Wert>;...[:CS]<CR>

or

RegisterName<Indize>;<Indize>;...=<Wert>;<Wert>;...[:CS]<CR>

- Register names generally consist of 3 non-numerical characters.
- Register names are accepted in upper and lower case letters.
- A register name is always followed by an index, which can also be two-dimensional. The dimensions are separated by a colon.
- If a range is specified for two-dimensional indexes, both the start and the end index must be specified in two dimensions.
- A register sequence must be terminated with <CR> at the latest after 127 characters.
- Characters with an ASCII-value of less than 32 will be ignored or, in case of control characters, interpreted accordingly.
- If a format is activated with time monitoring function and a started command sequence is not followed by the terminating <CR> at the latest after 100 msec, the complete sequence will be ignored.
- If the format is activated with checksum, only sequences with correct checksum will be evaluated. The checksum is generated by non-transfer addition of all utilization data via 8 bit and final formation of the one's complement. For output purposes the checksum is appended to the utilization data as a two-digit hexadecimal number in form of ASCII-characters, separated by semicolon. For inputs the same format is expected.
- Non-existing register sequences are ignored without any feedback (the correct execution of setting commands can be monitored by querying the corresponding register).
- If the <Value> is a string, it will be transmitted in " " and, in case of a transfer, this format is also expected.
- There is no monitoring of whether values are inside the permissible range. The transfer of impermissible values can lead to unexpected reactions of the device!
- Parameters with "Read" access can be released for writing, if desired.

Examples:

Single enquiry of the status of test pressure valve "Y2" on leak tester 3925-0065:

Command	Feedback
DOU1<CR>	0<CR>
	Or
	1<CR>

Multiple enquiry of the status of test pressure valve "Y2" and shut-off valve "Y3" on leak tester 3925-0065:

Command	Feedback
DOU1-2<CR>	0,0<CR>
Or	Or
DOU1;2<CR>	0,1<CR>
	Or
	1,0<CR>
	Or
	1,1<CR>

Single setting of the status of test pressure valve "Y2" on leak tester 3925-0065:

Command
DOU1=1<CR>

Multiple setting of the status of test pressure valve "Y2" and shut-off valve "Y3" on leak tester 3925-0065:

Command
DOU1-2=1;1<CR>
Or
DOU1;2=1;!<CR>

Further information concerning the command reference can be found in the command reference manual for the leak tester (PLC95).

Output format Record (Filling curve)

Setting up or changing the interface for record (filling curve) output

This section uses the interface **SER #1** as an example for setting up the output format for the record output.



Dialog window to set up the interface for Record data output

In order to set up an interface for the output of record data to a PC, you should select the Format: **Record**.

4. Sequencer

In the dialog window **SETUP SEQUENCER** you can set up or change a testing sequence with max. 10 test steps.

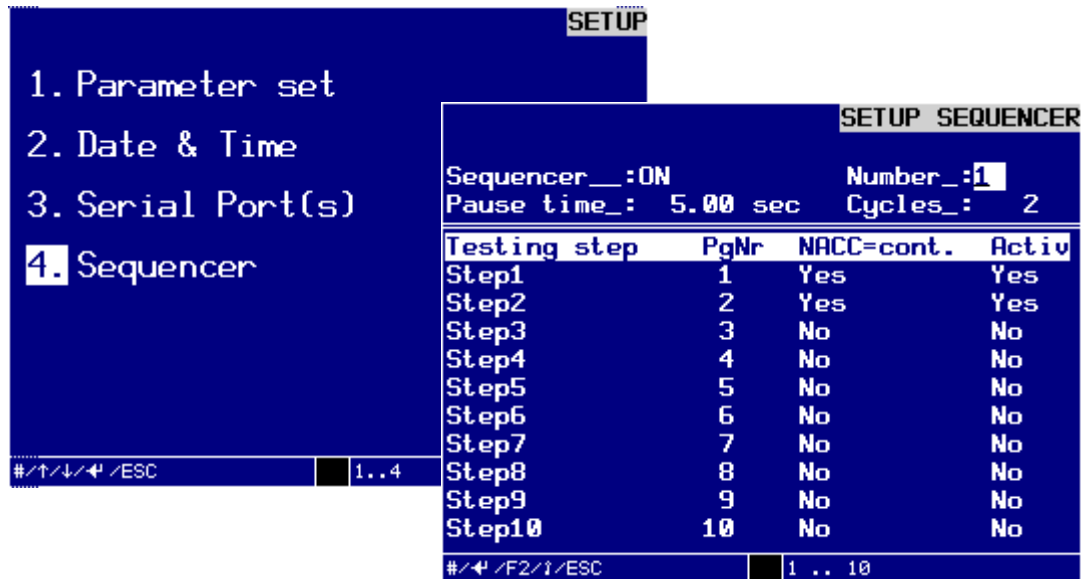

Dialog window *SETUP SEQUENCER*

- Turn the key switch clockwise to input mode, make the following entries and confirm each of them by pressing the **ENTER**-key:

Sequencer:

You can switch the sequencer to ON or OFF with the – and + keys. The default setting is OFF.

Number:

Enter the sequence number using the numbers 1 ... 10.

Pause time:

Enter the pause time in seconds from 0.10 ... 999.99. The default value is 30.00 sec.

The pause time is the time period to the start of the next sequencer cycle

Cycles:

Enter the cycles from 1 ... 9999. The default value is 1.

With the sequencer activated the sequences are repeated as often as specified under the item "Cycles" when setting up the sequencer for the corresponding sequencer program.

Step 1 ... 10:

For the steps of the test sequence enter a test program number using the numbers 1 ... 99.

N.O.K. continue:

For each step of the test sequence you can, in case of N.O.K.=continue with YES or NO, use the keys - and + to decide whether the next step of the test sequence should be performed.

ACTIVE:

For each step of the test sequence you can, in case of ACTIVE, use the keys - and + for YES or NO to decide whether the step of the test sequence is to be performed.

- Turn the key switch back to write protection ON.
An audible signal will sound and the device saves the changed data to the RAM memory.
- Press the **ESC**-key to exit the menu.

4.1 Printout SEQUENCER PARAMETER

Here you can decide whether the program parameters should be shown on the display or be printed out via an interface. Additionally you can select which program parameters should be displayed or printed out.

In the **MAIN MENU / 3. Setup** you will find the dialog menu **SETUP**.

In the Menü **SETUP / 1. Parameter set** you can select the program number. The program parameters will be shown in the display.



Dialog window SET PARAMETER

- Press key **F2** to activate the dialog window **PRINT DATA** for data transfer via interface.
On the display appears the window Print Data.

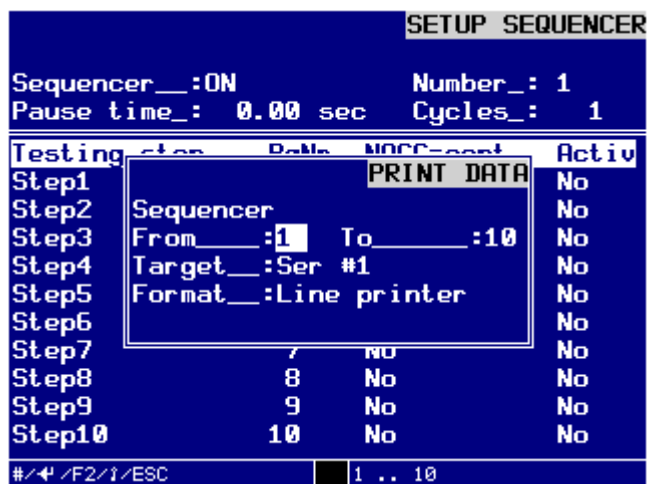

Set Parameter – Print Data

- **from: / to:**
Enter the range of previous program parameter you want to output into the text fields **from:** und **to:**, and confirm these individually with the **ENTER**-key. Possible entries range from 1 ... 10.

- **Target:**
Press the keys – and + to determine the desired **TARGET** for the data output:
You can select between:
Ser #1,
Ser #2,
USB-Stick.
Confirm the selection by pressing the **ENTER**-key.
- **Format:**
Press the keys – and + to determine the desired **FORMAT** for the data output:
You can select between:
LINE printer.
Confirm the selection by pressing the **ENTER**-key.
- You can output the selected program parameter through the selected interface by pressing the **F2**-key.
The message **Print data is active!** is display in the display.
- Press the **ESC**-key to exit the menu.

NOTE!

With a data output to a USB stick or external hard drive a file will be automatically generated. The file name consists of the serial number and the ending SEQ.

e.g. 10100100.SEQ

If a file with same file name already exists, the file will be opened and the data append to the file.



Menu 4. DELETE

In the **MAIN MENU / 4. Delete** you find the dialog window **DELETE**. In this menu you can delete data from the system, e.g. test programs, result memories and counters for the results No Leak, Rework and Leak.



Dialog window DELETE

	<p>NOTE! Operating hours, test counter, system parameters and error counts cannot be deleted by the operator.</p>
-------------------------------------------------------------------------------------	------------------------------------------------------------------------------------------------------------------------------

- Turn key switch clockwise.
The write protection is disabled and you can start to delete the desired parameters.
- Use the arrow keys to select the desired entries and press the keys – and + to toggle between **Yes** to delete and **No** not to delete.
- Specify the test programs from which you would like to delete these data by Edit the corresponding program numbers into the text fields **from:** and **to:** and confirming these individually by pressing the **ENTER**-key.
The insertion point jumps to the next field.

Once you have made and checked all entries, you can delete the selected data.

- Turn the key switch back to the vertical write protection position.
An audible signal will sound and the device will delete the data from the RAM memory.
- Press the **ESC**-key to exit the menu.

Menu 5. PRINT MENU

In the **MAIN MENU / 5. Print Menu** you find the dialog window **OUTPUT DATA**. In this menu you can specify where the data should be transferred to.

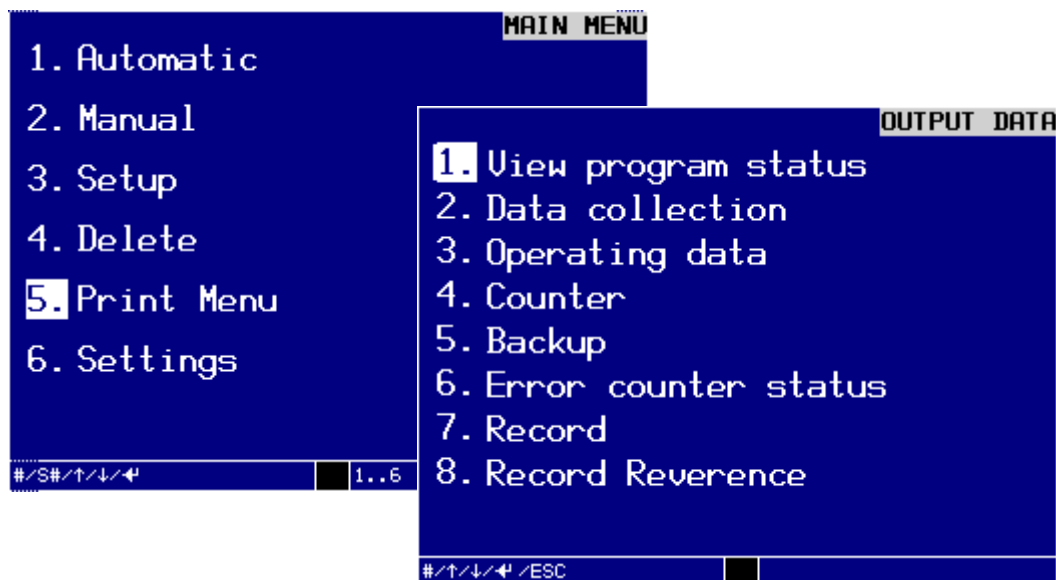

Dialog window DATA OUTPUT

In the sub-menus you can determine the output of the different data:

1. View Program Status

In the dialog window **PROGRAM STATUS** you can view all program numbers, which are already occupied, in the display. Program locations already used appear inverted.

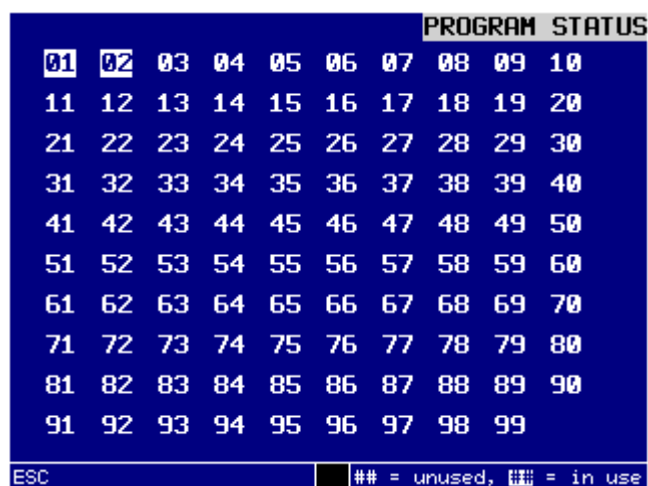

Dialog window PROGRAM OVERVIEW

2. Data Collection

Here you specify whether the test results from the data collection are to be output on the display or are to be transferred to a interface, and which results the output should contain.

In the Menü **OUTPUT DATA / 2. Data collection** you can select the range of data collection. The selected data collection will be shown in the display.

The screenshot shows two overlapping windows from a terminal interface. The background window is titled 'OUTPUT DATA' and lists eight menu options: 1. View program status, 2. Data collection (highlighted), 3. Operating data, 4. Counter, 5. Backup, 6. Error counter stat, 7. Record, and 8. Record Reverence. The foreground window is titled 'PRINT DATA COLLECTION' and shows a table of data with columns: Number, PC, Date, Time, Value, Unit, and Result. The 'From' field is set to 1 and the 'To' field is set to 14. The table contains 14 rows of data, with the last row showing a Pascal ERROR 13.

Number	PC	Date	Time	Value	Unit	Result
-1	2	25012010	110056	314	Pascal	Reject
-2	1	25012010	110040	320	Pascal	Reject
-3	2	25012010	110024	327	Pascal	Reject
-4	1	25012010	110008	358	Pascal	Reject
-5	2	25012010	105851	351	Pascal	Reject
-6	1	25012010	105835	365	Pascal	Reject
-7	2	25012010	105819	359	Pascal	Reject
-8	1	25012010	105803	415	Pascal	Reject
-9	2	25012010	105732	329	Pascal	Reject
-10	1	25012010	105716	437	Pascal	Reject
-11	1	25012010	105342	414	Pascal	Reject
-12	1	25012010	104926	410	Pascal	Reject
-13	1	25012010	103554	0	Pascal	Accept
-14	1	25012010	103427	-----	Pascal	ERROR 13

Dialog window DATA COLLECTION

- **from: / to:**
Enter the range of previous date collection you want to output into the text fields **from:** und **to:**, and confirm these entries with the **ENTER**-key.
Possible entries range from 1 ... 7000 (depending on the memory size).
- To confirm your input, press **ENTER** and the first 20 results will be shown in the display.
- You can press **ENTER** to view the next 20 results.
- Press the key **F2**, to activate the dialog window **PRINT DATA** for data transfer via interface.
On the display appears the window Print Data.

2.1 Print Data Collection

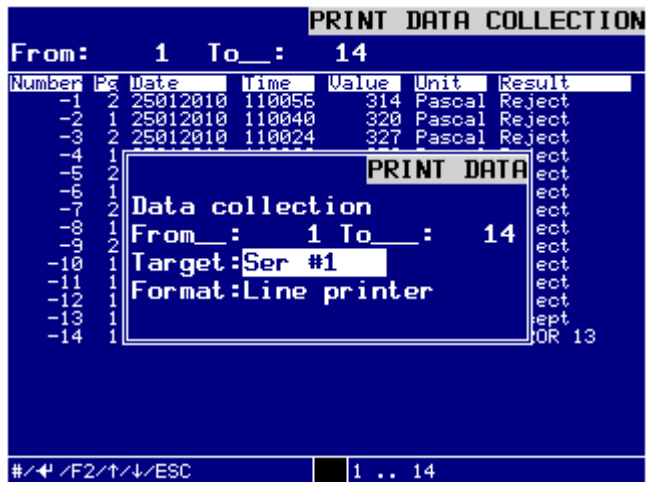

Dialog window – Print Data Collection

- from: / to:**
 Enter the range of previous date collection you want to output into the text fields **from:** und **to:**, and confirm these entries with the **ENTER**-key.
 Possible entries range from 1 ... 7000 (depending on the memory size).
- Target:**
 Press the keys – and + to determine the desired **TARGET** for the data output:
 You can select between:
Ser #1,
Ser #2 (optional),
USB-Stick.
 Confirm the selection by pressing the **ENTER**-key.
- Format:**
 Press the keys – and + to determine the desired **FORMAT** for the data output:
 You can select between:
LINE printer.
 Confirm the selection by pressing the **ENTER**-key.
- You can output the selected program parameter through the selected interface by pressing the **F2**-key.
 The message **Print data is active!** is display in the display.
- Press the **ESC**-key to exit the menu.

3. Operating data

Here you can view the complete operating hours and the number of all tests the test device has performed.

Dialog window OPERATING DATA

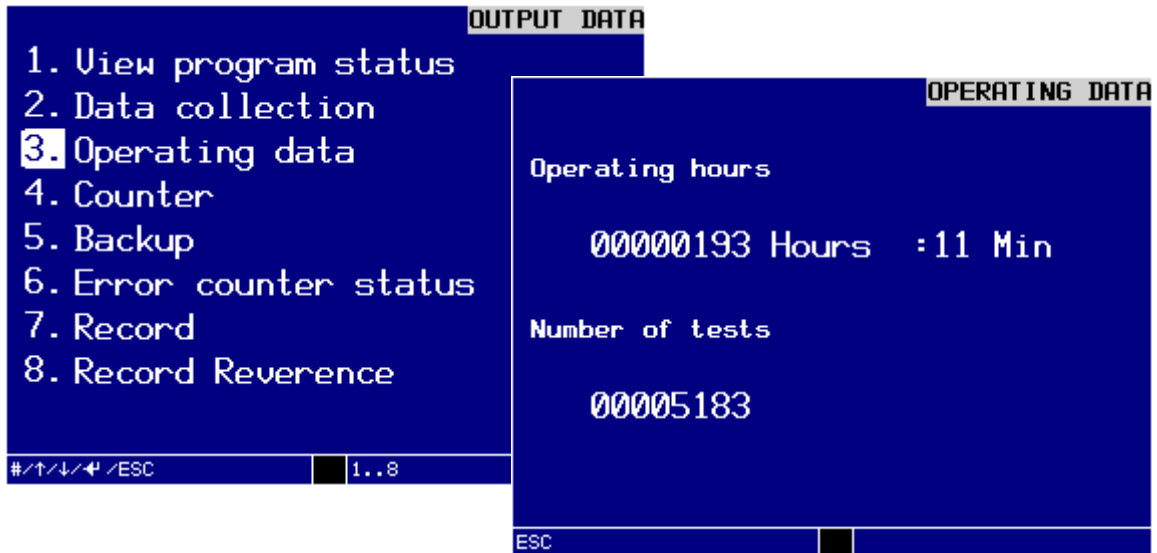

4. Counter

Here you can view the data of the test program result counter on the display.

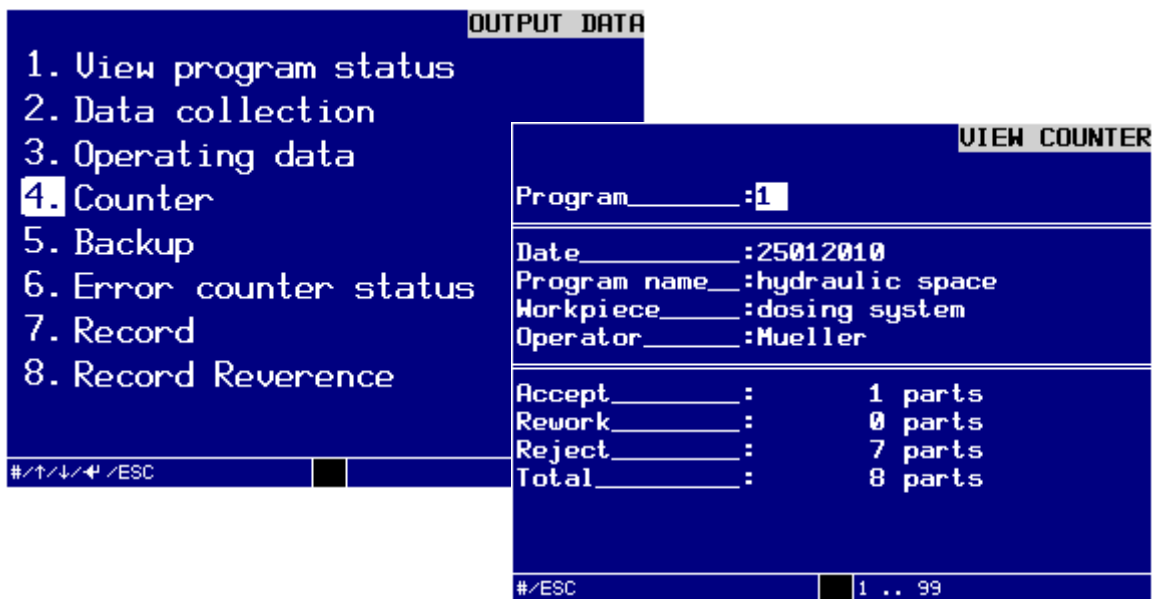

Dialog window VIEW COUNTER

- Enter the number of the test program into the field **Program:** and press the **ENTER**-key to confirm.
The result counters of the desired program are displayed.
- Press the **ESC**-key to exit the menu.

5. Backup

Here you can output or read in all data regarding the device, program and result data via the USB interface.



Dialog window ERROR COUNTER STATUS

The concept of data backup is based on the register programming. This allows additional to the pure backup a editing of the data with a standard text editor. Since each value is clearly defined by a register name and registration number, the values can be passed in any order.

To change the following values, just turn the key to the right, in horizontal position. If you have chosen your backup parameters, just turn the key back in vertical position. The Backup will start.

Parameter set_: YES/NO

You can use the buttons – and + to choose YES or NO. The proposed entry is NO.

From_: - -

Here you can select from which program number, the data will be stored. For selection of the data being backed up, you can enter a test program number with digits from 1 ... 99th. The proposed entry is 1.

To_: - -

Here you can select from which program number, the data will be stored. For selection of the data being backed up, you can enter a test program number with digits from 1 ... 99th. The proposed entry is 99.

Sequencer_: YES/NO

You can use the buttons – and + to choose YES or NO. The proposed entry is NO.

Data collection_: YES/NO

You can use the buttons – and + to choose YES or NO. The proposed entry is NO.

Records_: YES/NO

You can use the buttons – and + to choose YES or NO. The proposed entry is NO.

System parameters_: YES/NO

You can use the buttons – and + to choose YES or NO. The proposed entry is NO.

Pressure chart_: YES/NO

You can use the buttons – and + to choose YES or NO. The proposed entry is NO.

Direction_: - -

Here you can select the direction for data backup. You can use the buttons – and + to choose Output or Input. The proposed entry is output.

Output to output the data.

Input to receive data.

File name_ : - -

Here you can enter the file name for the backup. The file name can max. Be 8 characters long. The file extension .pbk is predefined for the file. The proposed entry is the serial number of the device e.g. 10100100.

6. Error counter status

In this menu you can view the error counters on the display. Unoccupied error numbers are identified by dashes.

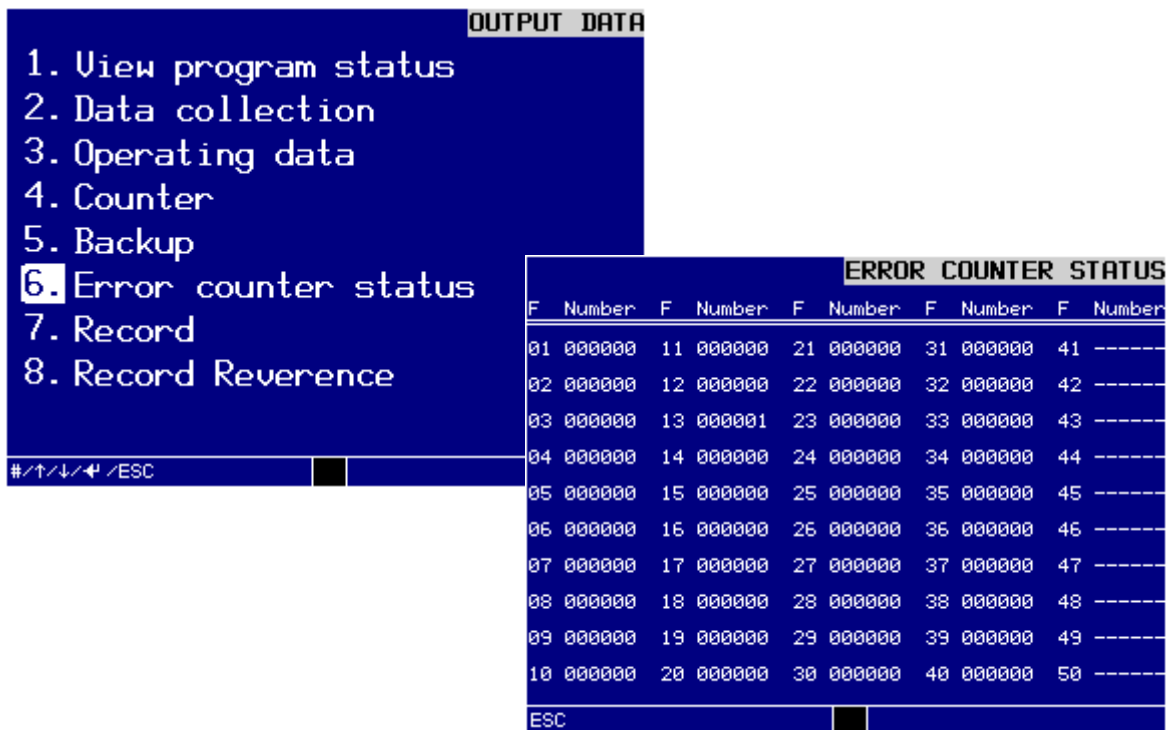

7. Record

In this menu you can view the recorded reference curve in the display.



Dialog window RECORDING

The output of the stored recording can be made.

- Enter the number of the record into the field **Record:** and confirm the entered record number with the **ENTER**-key.
The selected recording appears on the display.
Possible entries range is from -10 ... -1.

The possible range is displayed dynamically in the help bar of the menu.

The stored recordings are chronologically reversed.

This means, -1 shows the recording of the last (most up-to-date) test process, -2 the recording of the test process before this one, etc.

After the tenth test process the recording memory works as a loop memory and thus the eleventh test will overwrite the recording of the first test.

If no recording is stored, no entries can be made.

-
- Enter the number of the record into the field **Record:** and confirm the entered record number with the **ENTER**-key.
The selected recording appears on the display.
Possible entries range is from -10 ... -1.

The possible range is displayed dynamically in the help bar of the menu.

- Press the **ESC**-key to exit the menu.
- Press the key **F2**, to activate the dialog window **PRINT DATA** for data transfer via interface.
On the display appears the window Print Data.



Dialog window – Print Recording

- **from: / to:**
Enter the range of previous date collection you want to output into the text fields **from:** und **to:**, and confirm these entries with the **ENTER**-key.
Possible entries range from -1 ... -10.
- **Target:**
Press the keys – and + to determine the desired **TARGET** for the data output:
You can select between:
Ser #1,
Ser #2 (optional),
USB-Stick.
Confirm the selection by pressing the **ENTER**-key.
- **Format:**
Press the keys – and + to determine the desired **FORMAT** for the data output:
You can select between:
Record.
Confirm the selection by pressing the **ENTER**-key.
- You can output the selected recording via the selected interface by pressing the **F2**-key.
The message **Print data is active!** is display in the display.
- Press the **ESC**-key to exit the menu.

8. Record Reversion

In this menu you can view the last 10 saved filling curves on the display.

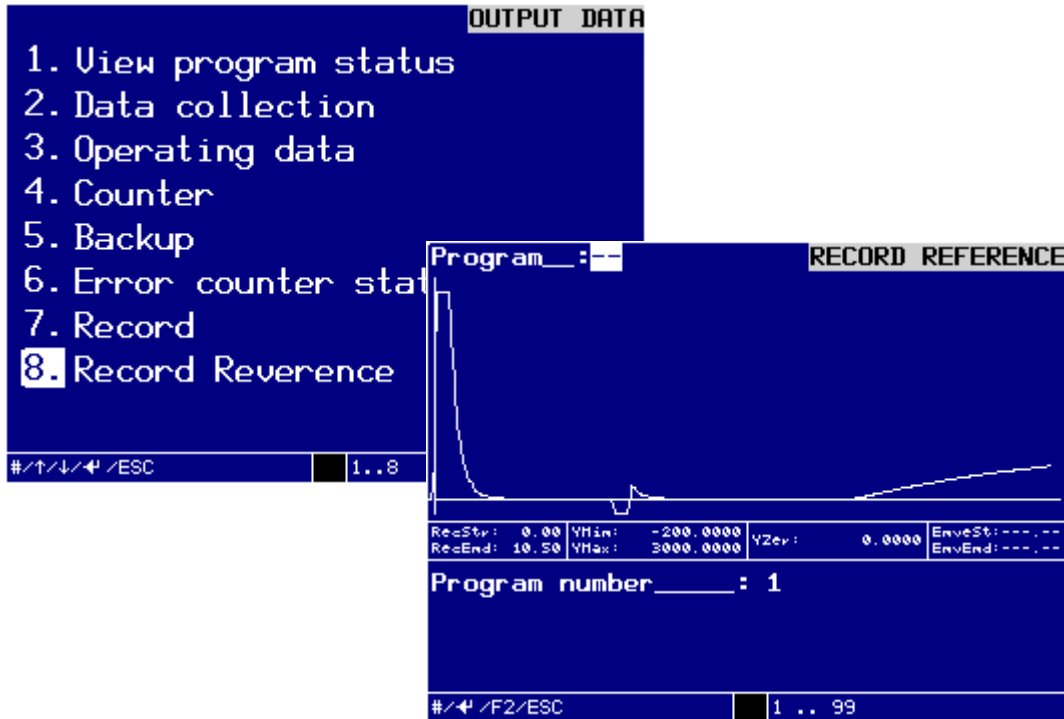

Here you can output of the saved record reference.

- Enter the number of the program into the field **Program:** and confirm the entered program number with the **ENTER**-key.
The selected recording appears on the display.
Possible entries range is from 1 ... 99.
- Press the **ESC**-key to exit the menu.

- Press the key **F2**, to activate the dialog window **PRINT DATA** for data transfer via interface.
On the display appears the window Print Data.



Dialog window – Print Record Reference

- from: / to:**
Enter the range of previous date collection you want to output into the text fields **from:** und **to:**, and confirm these entries with the **ENTER**-key.
Possible entries range from 1 ... 99.
- Target:**
Press the keys – and + to determine the desired **TARGET** for the data output:
You can select between:
Ser #1,
Ser #2 (optional),
USB-Stick.
Confirm the selection by pressing the **ENTER**-key.
- Format:**
Press the keys – and + to determine the desired **FORMAT** for the data output:
You can select between:
Record.
Confirm the selection by pressing the **ENTER**-key.
- You can output the selected recording via the selected interface by pressing the **F2**-key.
The message **Print data is active!** is display in the display.
- Press the **ESC**-key to exit the menu.

Menu 6. SETTINGS

In the **MAIN MENU/ 6. Settings** you find **SETTINGS**.

In this menu you can set the display, view and output system parameters, change the pressure control, view the input and output signals and set the switch-on masks and the machine control.



Dialog window SETTINGS

You can make the individual settings in the sub-menus:

1. Display

In this dialog window you can make the necessary display settings like language, mode, brightness and contrast.



Dialog window SETUP DISPLAY

- Turn key switch clockwise.
The write protection is disabled and you can start with the settings.
- Press the keys – or + to select the desired setting and press **ENTER** to confirm.
The insertion point jumps to the next subject.

Language

Here you select the language for the text display.

Mode

Here you specify the appearance of the display:

- black text on white background (standard)
- white text on black background (inverse)

Brightness

Here you can make the display lighter or darker. The corresponding brightness value is represented by the bar with numbers ranging from 0 ... 255. Changes are directly visible on the display.

Contrast

Here you can change the contrast of the display. The corresponding contrast value is represented by the bar with numbers ranging from 0 ... 255. Changes are directly visible when changing.

- Make sure you have made all necessary settings.
- Turn the key switch back to the vertical write protection position. An audible signal will sound and the device saves the changed data to the RAM memory.
- Press the **ESC**-key to exit the menu.

2. System parameters

In this menu you can view the settings of all system parameters and output these through the interface Ser #1.

- Press key ↑ or ↓ to scroll through the following five pages:

```

SETTINGS
1. Display
2. System parameters
3. Pressure control
4. System status
5. Options

Type: DHP0060-00
Hardware vers.: 1
Software vers.: 2.03
System MCU: 1.00
System CCU: 1.00
Software rev.: 4
System DCU: 2.14
CPLD version: 1.00
Job number: P0000001
Language: English
Serial number: 00000001
Brightness: 128
Color scheme: Blue/White
Interface 1: RS232
BdRate 0: 8 1 No No Line printer 0
Interface 2: -----
BdRate 0: 8 1 No XON/XOFF Line printer 0
USBStickFormat: Line printer

# / ↑ / ↓ / ← / → / ESC 1..5
ESC / PgUp / PgDn / F2
  
```

The first dialog window SETTING SYSTEM

```

SETUP SYSTEM
Analog inputs
No MinBit MaxBit Minimum Maximum Dir
00 12591 63034 -200.0000 3000.0000 0
01 12541 62851 0.0000 1.0005 0
02 0 65535 0.0000 1.0000 0
03 0 65535 0.0000 1.0000 0
04 0 65535 0.0000 1.0000 0
05 0 65535 0.0000 1.0000 0
06 0 65535 0.0000 1.0000 0
07 0 65535 0.0000 1.0000 0

Analog outputs
No MinBit MaxBit Minimum Maximum Dir
00 +3241 +16278 0.0000 2.0270 0
01 +3170 +15972 0.0000 1.0000 0
02 +3170 +15972 0.0000 1.0000 0
03 +3170 +15972 0.0000 1.0000 0

ESC / PgUp / PgDn / F2
  
```

The second dialog window SETTING SYSTEM

```

SETUP SYSTEM
Parameter Min Max Default Unit Edit
Program no: 1 99 1 X 1
Date: 00000000 99999999 00000000 X 0
Program name: 1 23 23 X 1
Workpiece: 1 23 23 X 1
Operator: 1 23 23 X 1
Fill pressure: 0.10 1.00 1.00 bar 1
FillPresOnOff: Off ON X 2
Underfill prst: 0.10 1.00 0.80 bar 1
Underfill tim: 0.00 10.00 0.30 sec 1
Test pressure: 0.10 1.00 0.90 bar 1
TestPresOnOff: ON ON X 2
Press. tol.: 0.5 10.0 1.0 % 1
Fill time: 0.10 999.99 3.00 sec 1
Stabil. time: 0.10 999.99 3.00 sec 1
Pause time: 0.00 999.99 1.00 sec 1
AutoZero time: 0.00 999.99 0.50 sec 1
Measure time: 0.10 999.99 3.00 sec 1
Vent time: 0.10 999.99 1.00 sec 1
Vent OnOff: Off ON X 2
Unit: Pascal ml/min Pascal X 2
Fixtur.offset: -300 300 0 Pa 1

ESC / PgUp / PgDn / F2
  
```

The third dialog window SETTING SYSTEM

SETUP SYSTEM					
Parameter	Min	Max	Default	Unit	Edit
Vol. multipl_	0.000001	9.999999	1.000000	%	1
Rework limit_	1	2000	100	%	1
Rework OnOff_	0ff	ON	ON	%	2
Reject limit_	1	2000	200	%	1
Reject OnOff_	ON	ON	ON	%	2
Cons. reject_	0	999	5	par	1
Protocol to_	0ff	USB-Stick	Ser #1	%	2
EnvelopeTol_	0.50	25.00	1.00	%	1
EnvelopeOnOff_	0ff	ON	0ff	%	2
Record start_	0.00	999.99	0.00	sec	1
Record end_	0.10	999.99	3.00	sec	1
EnvelopeStart_	0.00	999.99	0.00	sec	1
Envelope end_	0.10	999.99	3.00	sec	1
NumDeciPa:0, mbar:2, psi:4, mmHg:1, mmHg:2, ml/min:1					
Initial menu:Main menu			PressCorr:0.5		
Test methode:PressureDrop Diff			PressKNeg:-0.100		
I/O configur.:Automatic			PressKPos:0.090		
E4Min:-100	E4Max:100	E10:-100	E13:-10	GL:540	
ESC/PgUp/PgDn/F2					

The fourth dialog window SETTING SYSTEM

- Press key **F2** to output the system parameters via interface .

SETUP SYSTEM	
Type	:DHP0060-00
Hardware vers.	:1
Software vers.	:2.03
System MCU	:1.08
System CCU	:1.00
Software rev.	:4
System DCU	:2.14
CPLD version	:1.00
Job number	:P0000001
Serial number	:00000001
Language	:English
Brightness	:128
Color sch	
PRINT DATA	
System parameters	
Interface	Hdr
Rate	er 0
115200	8
Interface	Hdr
Rate	er 0
9600	8
USBstickF	
ESC/PgUp/PgDn/F2	

The dialog window SETTING SYSTEM – PRINT DATA

- Press the **ESC**-key to exit the menu.

3. Pressure control

In this menu you can redetect the settings for the pressure control (electronic pressure control).



Dialog window *SETUP PRESSURE CONTROL* before start

- Press key **F2** to redetect the parameters for the pressure system. This process takes a few minutes. You can follow the sequence by the progress bar.

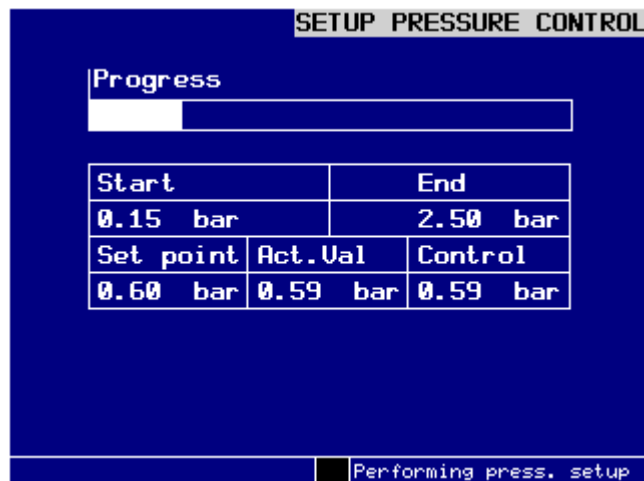

Dialog window *SETUP PRESSURE SYSTEM* during detection

Once the test device has determined the parameters for the pressure system, the device is reset and rebooted.

After the boot process the display will show the dialog window specified under

Error in pressure detection

If there should be problems with the pressure detection, the following dialog window will appear:



Dialog window SETUP PRESSURE CONTROL WINDOW with error message

This dialog window offers two possibilities to respond to this error message:

- Eliminate the cause of the fault.
Further information can be found under position 27 of the *Trouble shooting chart* in chapter *Maintenance*.
- Accept maximum pressure.
The system determines the pressure table new up to the currently possible maximum pressure. If higher pressure than the determined maximum pressure is programmed during setup, the tester will submit the error 28 *Nominal pressure out of range*. In this case refer to the *Trouble shooting chart* in chapter *Maintenance*.

4. System status

In this sub-menu you can view the input and output signals of the interface to the machine control:

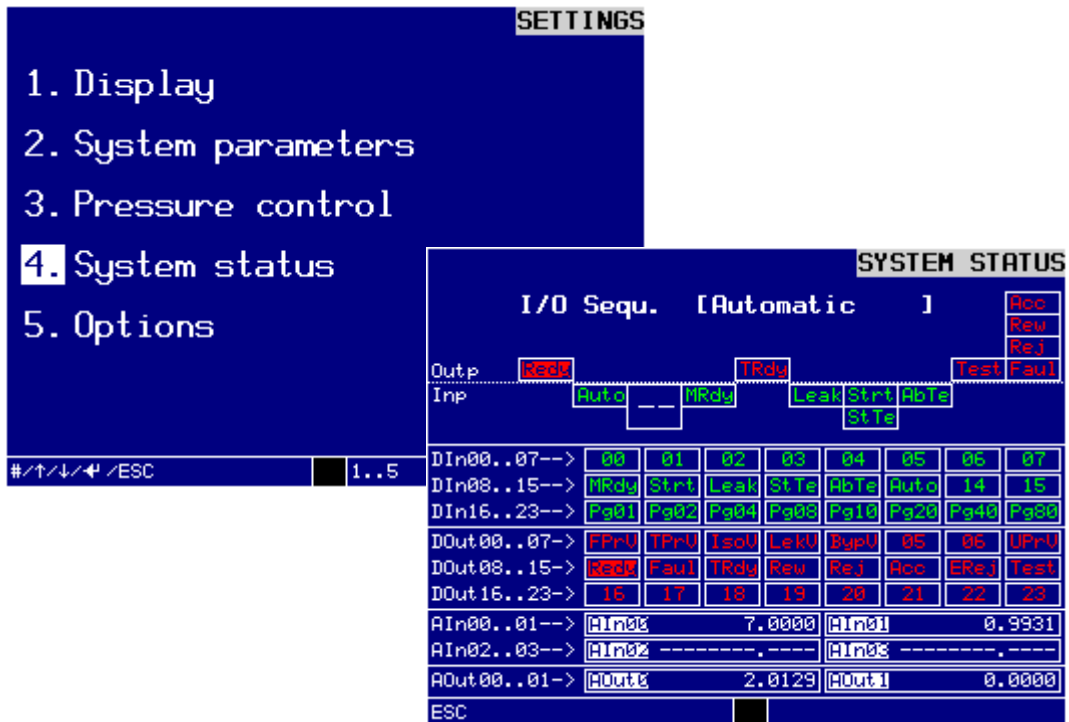

Dialog window SYSTEM STATUS

Applied signals are shown inverse. All applied inputs and outputs are shown in the following sequence:

- outputs of tester
- inputs of tester
- digital inputs of electronic module (DIn00..23)
- digital outputs of electronics module (DOut00..23)
- analog inputs of electronic module (AIn00..03)
- analog outputs of electronics module (AOut00..01)

During the program sequence you can directly follow the signal sequence of inputs and outputs.

- Press the **ESC**-key to exit the menu.

5. Options

In the dialog window **SETUP OPTIONS** you can set up the start menu, the interface format for machine control and the limits for error 13.

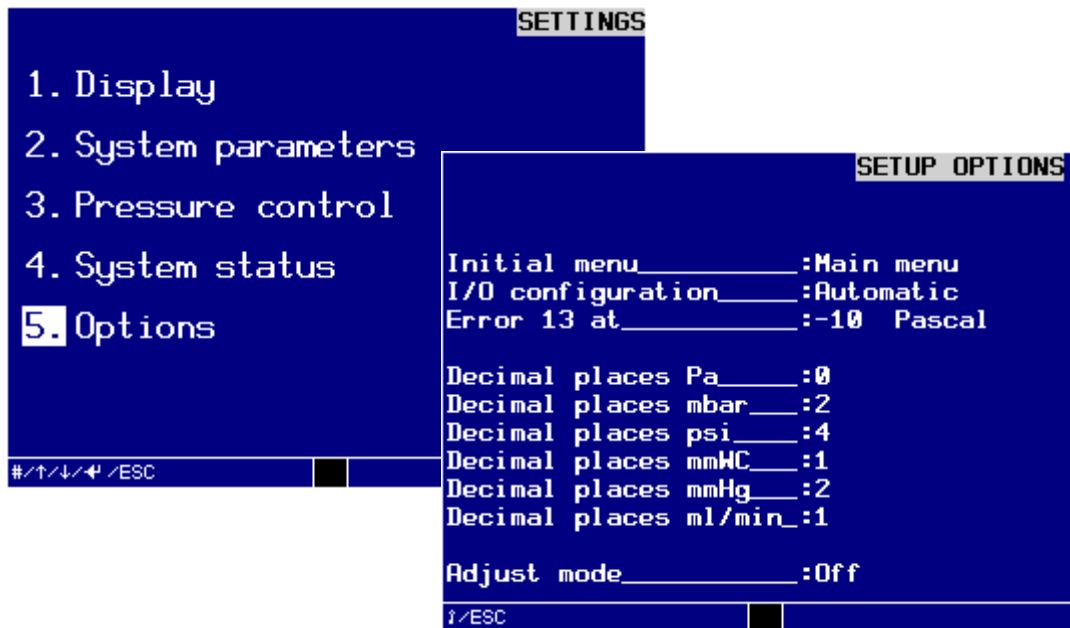

Dialog window *SETUP OPTIONS*

- Turn key switch clockwise.
The write protection is disabled and you can start with the settings.
- Press the keys – or + to select the desired setting and press **ENTER** to confirm.
The insertion point jumps to the next subject.

Initial menu

Here you specify in which menu the device should start after switching on:

- Automatic
- Manual
- Main menu

I/O configuration

Here you specify which I/O configuration the leak tester should use for machine control. Chapter *Signal exchange with machine control* contains detailed information on these adjustment possibilities. You can choose from:

- Automatic
- Semi-automatic
- Minimal

Error 13 from

This value specifies from which Pascal value the device should report error signal 13. The value can be in the range from -999 ... 0 Pascal.

	<p>ATTENTION! The error limit F13 is defined as -10 Pa by default. Any other value could result in faulty measurements. This value should therefore only be changed in consultation with HEMATECH PRÜFTECHNIK.</p>
-----------------------------------------------------------------------------------	-------------------------------------------------------------------------------------------------------------------------------------------------------------------------------------------------------------------------------

Decimal places Pa

Here you can select the number of decimal places of measurement unit **Pa**. This value determines in what number of decimal places the measurement unit is displayed.

The range is 0 ... 2.

The default value is 0

Decimal places mbar

Here you can select the number of decimal places of measurement unit **mbar**. This value determines in what number of decimal places the measurement unit is displayed.

The range is 0 ... 3.

The default value is 0

Decimal places psi

Here you can select the number of decimal places of measurement unit **psi**. This value determines in what number of decimal places the measurement unit is displayed.

The range is 0 ... 4.

The default value is 4

Decimal places mmWC

Here you can select the number of decimal places of measurement unit **mmWS**. This value determines in what number of decimal places the measurement unit is displayed.

The range is 0 ... 1.

The default value is 1

Decimal places mmHg

Here you can select the number of decimal places of measurement unit **Hg**. This value determines in what number of decimal places the measurement unit is displayed.

The range is 0 ... 2.

The default value is 2

Decimal places ml/min

Here you can select the number of decimal places of measurement unit **ml/min**. This value determines in what number of decimal places the measurement unit is displayed.

The range is 0 ... 3.

The default value is 1

- Make sure you have made all necessary settings in this dialog window.
- Turn the key switch anti-clockwise again to switch the write protection ON. An audible signal will sound and the device saves the changed data to the RAM memory.
- Press the **ESC**-key to exit the menu.

Testing and Setup

Testing the leak tester

In order to ensure correct functioning of the leak tester Leak Test 0050 and reliability of the measuring results, you should run a device self test before each use. This test should be performed without specimen, to achieve a reliable result.

Performing the self-test

- Make sure that the compressed air supply to the device is filtered and free of oil. Check the filter to be on the safe side.
- Make sure that the supply air pressure is 1.5 bar/ü higher than the adjusted test pressure, minimum and maximum values are specified in the pressure table on the back of the device.
- Make sure that the connections for specimen and reference volume are closed with the supplied caps pressure tight.
- Set up the test program with the following test parameters:

Filling pressure	2.10 bar/ü,	OFF
Underfilling pressure	1.90 bar/ü	
Test pressure	2.00 bar/ü	
Filling time	3.0 sec	
Underfilling time	0.3 sec	
Stabilization time	3.0 sec	
Pause time	1.0 sec	
Tare time	0.5 sec	
Measuring time	3.0 sec	
Venting time	1.0 sec,	OFF
Pressure tolerance	1.0 %	
Measuring value unit	Pascal	
Volume factor	1.0000	
Rework 1 from	10.0 Pa,	ON
Leak from	50.0 Pa,	ON
Series fault from	5	
Protocol		OFF

- Turn the key switch back to the vertical write protection position. An audible signal will sound and the device will write the data to the RAM memory.

If the pressure values can not be adjusted because the tester has a lower pressure range, use the maximum possible test pressure for self testing.

- Press the **ESC**-key to change to the **MAIN MENU**.

- In the dialog window **MAIN MENU** select the menu **2. Manual/Test** and in the dialog window **TEST**, which will now open, enter the program number of the self-test program into the text field **Program**.
- Press key F2 to start execution of the program.

With an intact device the measuring values should not deviate for more as ± 2 Pa when repeating the measurement. The light emitting diode **NO LEAK** must light up after the measuring time has elapsed.

Performing a self-test with leak

When performing a self-test without specimen and a leak of 2,5 ml/min under a test pressure of 1 bar/ü over a measuring time of 3 s, the leak tester must indicate a measuring value of approx. 1700 Pa.

Setting up the device for specimen

Testing with filling pressure

When testing under filling pressure (shock filling) set the filling pressure approx. 0.2 bar/ü or 10 % higher than the test pressure. However, the exact filling pressure can only be determined with a specimen connected. To do so:

- Connect an absolutely leak tight specimen, position 20, to the specimen connection on the back of the tester.

The following applies as rule of thumb for the determination of the test times: filling time and stabilization time together must make up approx. 2/3 and the measuring time approx. 1/3 of the test sequence.

Stabilization time and filling time must be considered as independent functions:

- The filling time may set a trend for the measurement.
- The stabilization time stabilizes the measurement and thus the repetitive accuracy.

Example trend measurement

After the filling time has been set to 3 seconds the the stabilization time to 5 seconds, the measuring value indicator moves with constant speed to 50 Pa over a measuring time of 5 seconds.

When extending the filling time, the trend will be reduced e.g. to 5 ... 10 Pa with unchanged measuring time.

If the filling time is too long, the sign of the measuring value display for the trend measurement will change; the measuring value display moves below 0 Pa to the negative range.

Once you have determined the optimal filling time, you can exactly adjust the stabilization time. You can carry on reducing the stabilization time, as long as the measuring values remain repeatable with sufficient accuracy.

This measuring time depends on the leak rate to be measured and the setting of the limit contacts. This setting is bet be made with a specimen with limiting leak.

Testing without filling pressure

For testing without filling pressure (shock filling) you must consider the filling and stabilization times as connected times.

Filling and stabilization times must be dimensioned in such a way, that the measuring value display does neither jump, nor move for more than 5 Pa over a measuring period of 3 seconds, after the stabilization time has elapsed.

NOTE!



The cycle time can be reduced by shortening the filling or the stabilization time and to run a so-called trend measurement.

Example:

With a leak tight specimen the measuring value display moves for 10 Pa and with a specimen with limit leak it moves up to 20 Pa.

This measuring time depends on the leak rate to be measured and the setting of the limit contacts. This setting is bet be made with a specimen with limiting leak.

Maintenance

Maintenance of the device should be performed at regular intervals, depending on the utilization level (at least once per year). Maintenance of the device should be included in the company internal inspection intervals.

Maintenance contract

For devices manufactured by us you can, if desired, enter into a maintenance contract with HEMATECH PRÜFTECHNIK for regular inspections and preventive maintenance. We will inform you about the exact terms and conditions on request.

Maintenance plan

The following table shows the maintenance work required to maintain the tester in operable condition for normal operation.

Maintenance work	Schedule	Info
Check the service unit	Weekly	Check filter cartridges and replace if necessary
Perform a self-test	at every change of shift or specimen	see section Performing the self-test
Perform a self-test with leak or master specimen with leak	at least once a month	see section Performing self-test with leak
Clean the shut-off valve	every six months and annually in case of certification	Q1
Certification and calibration	Annually	by HeMaTech Prüftechnik GmbH & Co. KG
Buffer battery of RAM memory	every 10 years	by HeMaTech Prüftechnik GmbH & Co. KG

Errors, Causes and Remedy

The test device monitors valves, measuring transducers, specimen and the function sequence. In case of an error, this will be indicated by the measuring value display and printed out as error code via the connected printer, in Automatic mode a floating contact *Fault* will additionally be switched. A visual message *Error* will be emitted by light indicators.

Acknowledging error messages

Depending on the operation mode the error messages must be acknowledged in different ways:

Operation mode **MANUAL**

- After eliminating the error press the **ESC**-key to return to the dialog window MANUAL MENU,

or

- press the **ENTER**-key to repeat the selected function, after the error has been corrected.

Operation mode **AUTOMATIC (Auto)**

- After rectifying the error remove the signal AUTOMATIC (X 21/6).

Operation mode **AUTOMATIC (SemiAuto)**

- After rectification of the error apply the **START**-signal to interface (X 21/2),

or

- press the **ESC**-key

Operation mode **AUTOMATIC (Minimal)**

- After rectification of the error apply the **START**-signal to interface (X 21/2) again,

or

- press the **ESC**-key.

Trouble Shooting Chart

The following chart lists all error messages, which may be displayed during operation of the leak tester. Each error message has a number, which gives you the possibility to easily locate the possible cause and the corresponding remedial action in the chart. Should any faults not be listed in the chart, please do not hesitate to contact the customer service of HeMaTech Prüftechnik directly.

All activities in the column *Remedy*, which are marked with *, must only be performed by trained expert personnel.

No.	Message	Possible cause	Remedy
0		The tester is not correctly controlled	Change the control, see also chapter signal exchange with machine control
1	No operating pressure	No air supply on tester	Switch on the air supply and check the air hose
2	not used		
3	Program parameters do not exist	No test parameters in selected program	Enter test parameters in menu Setup/Test programs
4	Differential pressure measuring converter defective	Differential pressure measuring converter defective	Inform the customer service
		Zero point of differential pressure measuring converter out of adjustment	Readjust the differential pressure measuring converter*
		Output board defective X18	Replace the output board*
		Differential pressure measuring converter full of oil, water, ...	Clean and adjust the measuring circuit*
		Power supply unit defective	Check the voltage of the power supply unit*
		Breakage in connecting cable to differential pressure measuring converter	Check connecting cable*
		Shut-off valve defective	Replace the middle section of the shut-off valve*
5	not used		
6	not used		
7	not used		
8	not used		
9	not used		
10	Coarse leak (major)	Differential pressure	Check the test parameters

No.	Message	Possible cause	Remedy
	leak) in reference volume	measuring converter extremely deflects to minus during tare time	(filling time too long or filling pressure too high)
		Reference volume Leak	Check reference volume connection for leaks and clean the shut-off valve*
		Shut-off valve defective	Replace middle section of shut-off valve or diaphragm*
		Diaphragm of shut-off valve defective	Replace middle section of shut-off valve or diaphragm*
11	not used		
12	not used		
13	Fine leak in reference volume	Differential pressure measuring converter slightly deflects to minus during tare time	Check the test parameters (filling time too long or filling pressure too high)
		Reference volume leak	Check reference volume connection for leaks, clean the shut-off valve*
		Fixture reduces test volume	Check device for movement during measuring time
		Differential pressure measuring converter full of oil, water, etc.	Clean and readjust the measuring circuit*
		Shut-off valve defective	Replace the middle section of the shut-off valve*
14	Series fault	Preset series fault counter exceeded	Only Leak parts
		Sealing of device defective	Replace the sealing of the device
		Tester Leak	Perform a self-test
15	not used		
16	not used		
17	Overrun of the absolute pressure measuring converter	Pressure system outside tolerance	Redetermine the pressure system in menu 6. Settings/3. Pressure system
18	Limit contact for Leak cannot be exceeded	Test pressure too low	Test pressure too high, change limit contact
19	Pressure increase after closing the	Pressure increase in specimen	Check the device for any movements

No.	Message	Possible cause	Remedy
	shut-off valve		
20	Apex of filling time not reached	incorrect specimen	Check the specimen
		Supply line worn	Check the supply line
21	not used		
22	not used		
23	Filling pressure after expiration of filling time too low	Network pressure too low	Check the network pressure (see chapter <i>Connecting the test medium hose</i>)
		Coarse leak on specimen	Check the specimen
		Pressure system outside tolerance	Redetermine the pressure system in menu 6. Settings/3. Pressure system
		Filling time too short	Check the filling time
24	Filling pressure after expiration of filling time too high	Pressure system outside tolerance	Redetermine the pressure system in menu 6. Settings/3. Pressure system
25	Filling pressure after expiration of stabilization time too low	Network pressure too low, coarse leak on specimen,	Check the network pressure (see chapter <i>Connecting the test medium</i>)
		Pressure system outside tolerance	Redetermine the pressure system in menu 6. Settings/3. Pressure system
		Stabilization time too short	Check the stabilization time
26	Filling pressure after expiration of stabilization time too high	Pressure system outside tolerance	Redetermine the pressure system in menu 6. Settings/3. Pressure system
		Shut-off valve defective	Replace the middle section of the shut-off valve*
27	Pressure system not adjustable	Network pressure too low	Check the network pressure (see chapter <i>Connecting the test medium</i>)
		Test medium connection not connected	Connect the test medium connection
		Pressure system defective	Inform the customer service
		Output board X5 defective	Replace the output board*
		P/I-converter defective	Replace the P/I-converter*
28	Rated pressure out of range	Network pressure too low during pres-	Redetermine the pressure system in menu 6. Settings/3.

No.	Message	Possible cause	Remedy
		sure determination	Pressure system
29	not used		
30	not used		
31	not used		
32	not used		
33	not used		
34	not used		
35	not used		
36	not used		
37	Test pressure in sequence too low	Coarse leak (major leak) on specimen, (under pressure), otherwise like error 25	
38	Test pressure in sequence too high	Coarse leak (major leak) on specimen, (under vacuum), otherwise like error 26	
39	No reference curve	Generate a reference curve	
40	No test step activated	Activate test step in sequencer	

Signal Exchange with Machine Control

Signal description via parallel interface (machine control)

Automatic	Signal from the machine control (PLC)
Ready for operation	Signal to machine control (PLC)
Machine ready	Signal from the machine control (PLC)
Program number	Signal from the machine control (PLC)
Ready for test	Signal to machine control (PLC)
Test result	Signal to machine control (PLC)
Start (measurement)	Signal from the machine control (PLC)
Abort	Signal from the machine control (PLC)
Fault	Signal to machine control (PLC)
Measuring device busy (optional)	Signal to machine control (PLC)

Automatic must be a permanent signal, which is already applied when switching on the test device.

Ready for operation is submitted by the test device after switching on.

Machine ready is applied after the signal Automatic and Ready for operation and removed when applying the signal Start. Together with the signal "machine ready" the applied program number is read in.

Program number may be permanent signals.

Ready for testing is set after the tester has read in the program number.

Start should be an approx. 1 second pulse.

Test result (No Leak, Rework, Leak (UT, O.K. or LT)) remains valid, until a new signal Machine ready is applied again.

Abort

If the signal **Abort** is set during the measurement, the test in progress will be aborted and the signal "Ready for operation" will be set.

For subsequent testing the signal **Machine ready** must be applied again.

Error is reset when removing and renewing the signal **Automatic**.

Measuring device busy (optional) will be submitted from the start to the end of a test.

Automatic operation

The signal **Automatic** must be applied, followed by the signal **Machine ready**, the output signal **ready for test** is set and the selected Program number is read in. The signals **Ready for operation** and test result are reset at the same time. Now the measurement can be triggered with the signal **Start** (pulse of approx. 1 second). Remove the signal **Machine ready**. Once the measurement is finished, the test result (no leak, Leak or rework) is submitted and the output **ready for operation** is set.

NOTE!



The signal **machine ready** must be set before each measurement, whereby the signal for program selection may always be present.

Flow chart of automatic operation

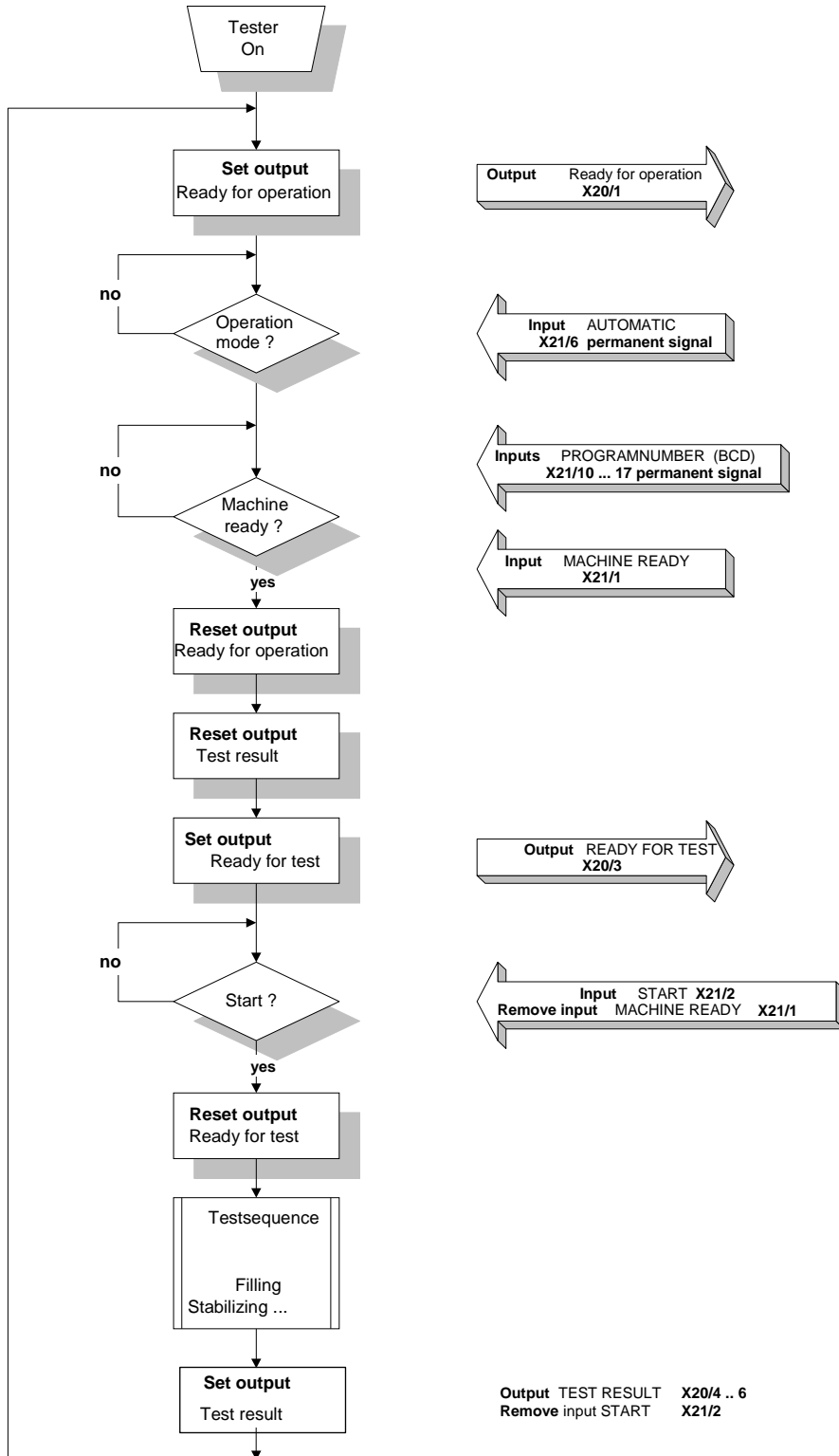

Automatic operation in a time-way diagram

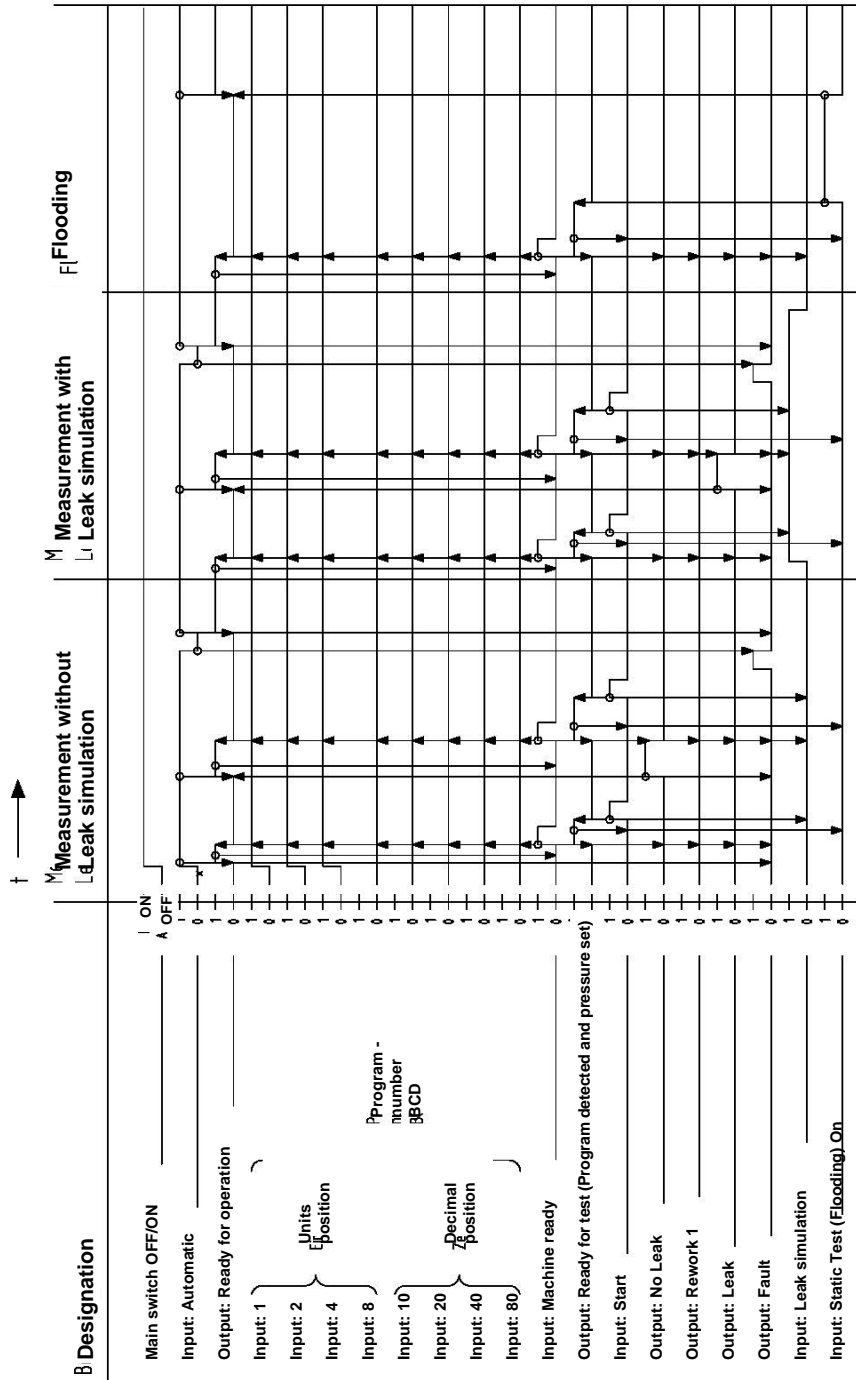

In semi-automatic operation

The signals **Automatic**, **Machine ready** and **Ready for test** are not used in this operation mode.

The program number are entered or changed via the keypad.

When the tester is switched on, the output **Ready for operation** is set.

Now the measurement can be triggered with the signal **Start** (pulse of approx. 1 second), the test result is deleted.

Once the measurement is finished, the test result (leak tight, Leak or rework) is submitted and the output **Ready for operation** is set.

Flow chart of semi-automatic operation

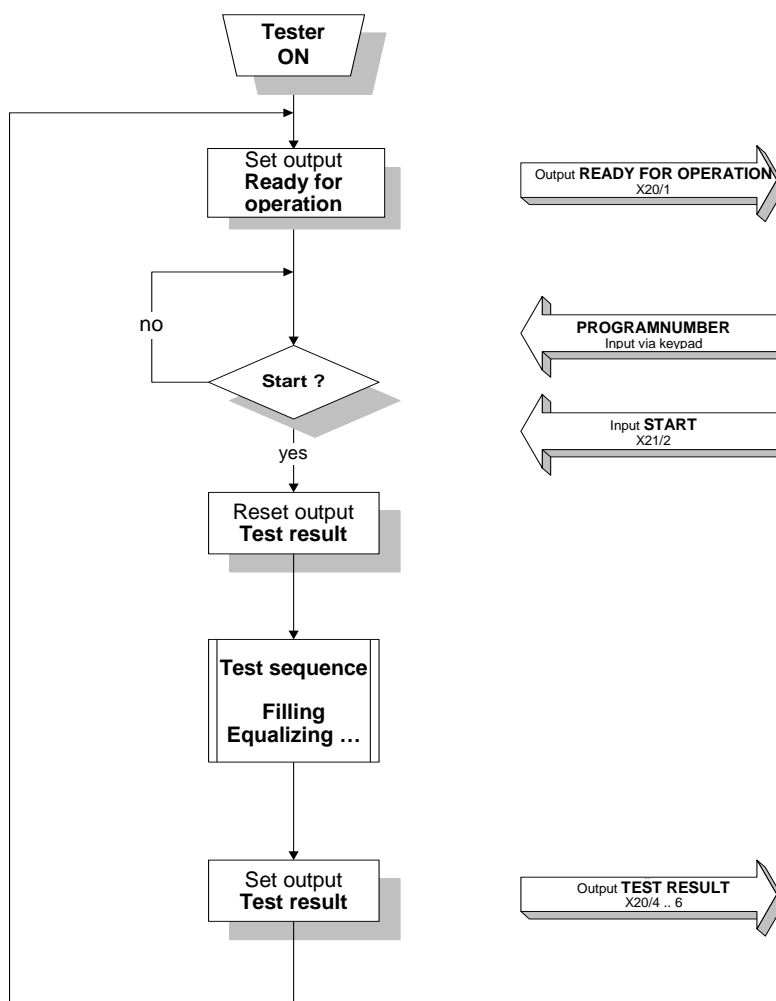

Semi-automatic operation in a time-way diagram

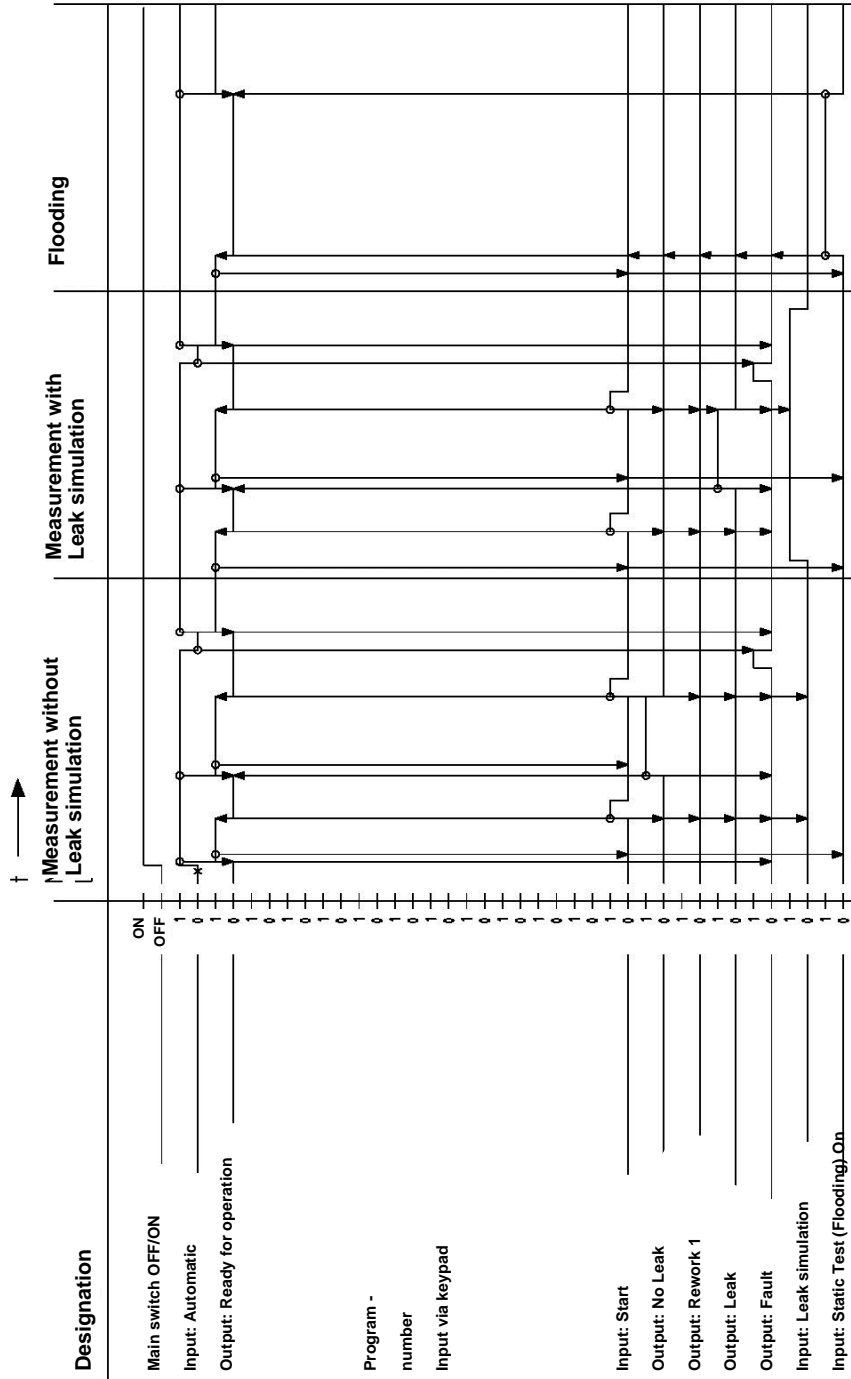

The input "Start" should be a pulse with a length of approx. 1 seconds.

*Entry point after removing the signal "Abort". This signal deletes all outputs and interrupts the measuring process at any point (only in automatic mode). The specimen is vented (e.g. for emergency stop).

In minimal operation

The signals **Automatic**, **Machine ready** and **Ready for test** are not used in this operation mode.

The program numbers are read in at the start as binary code.

When the tester is switched on, the output **Ready for operation** is set.

Now the measurement can be triggered with the signal **Start** (pulse of approx. 1 second), the test result is deleted.

Once the measurement is finished, the test result (leak tight, Leak or rework) is submitted and the output **Ready for operation** is set.

Flow chart for minimal operation

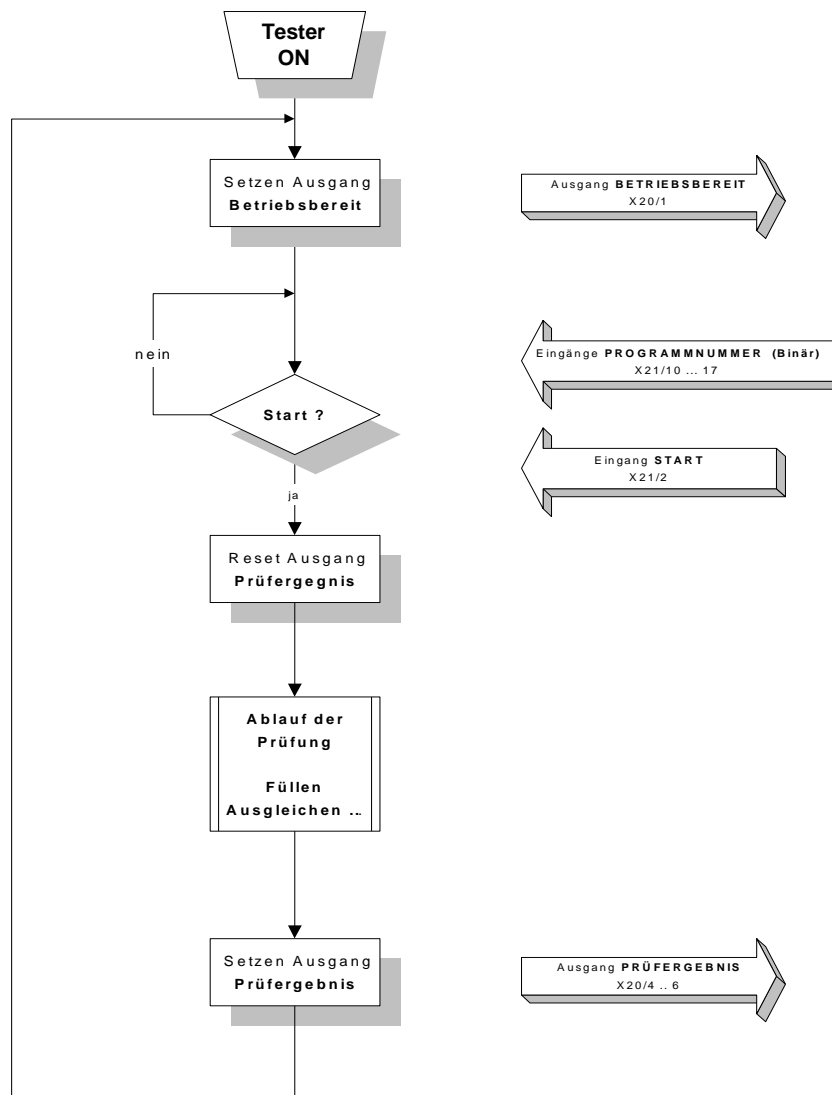

Minimal operation in a time-way diagram

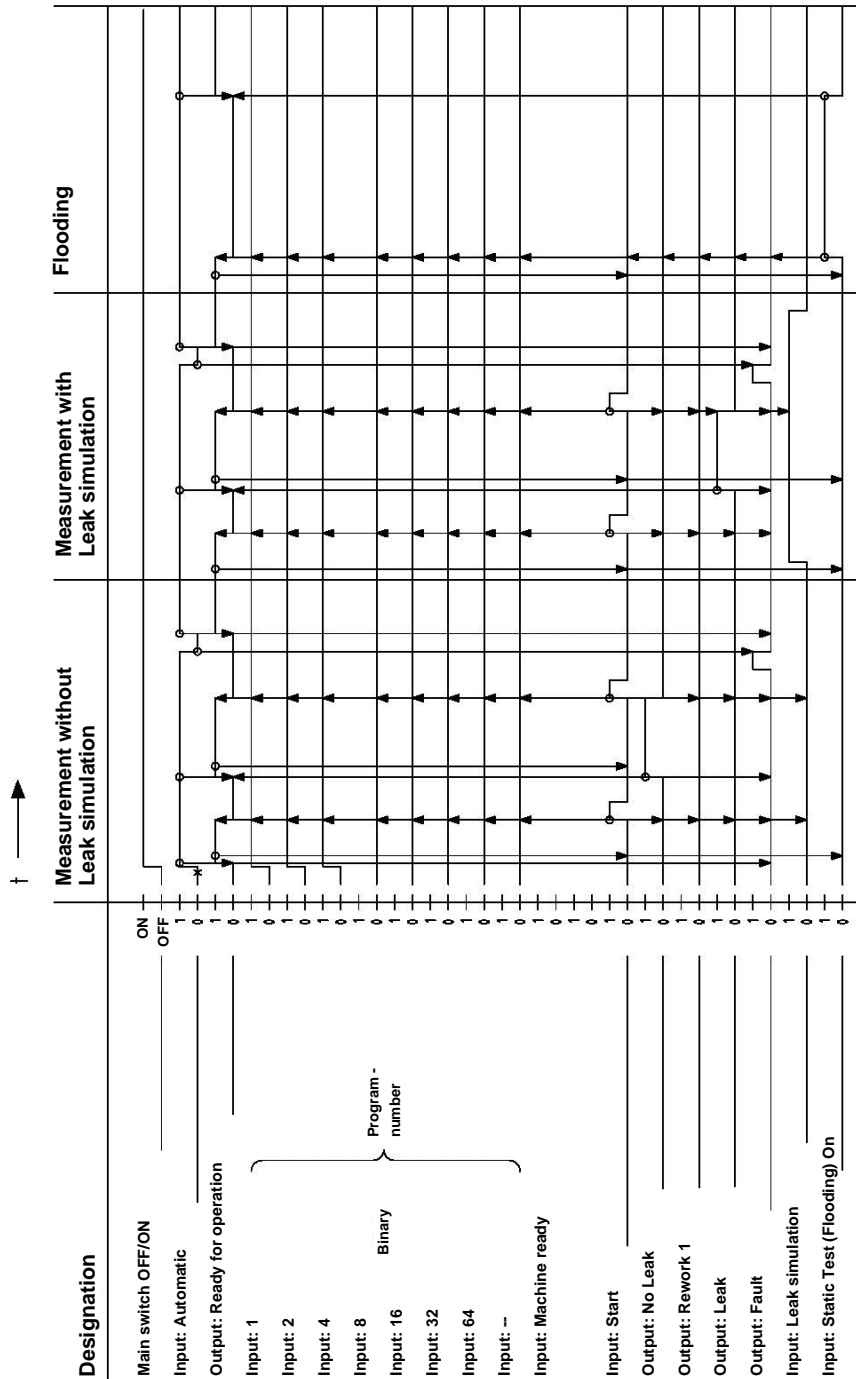

(Program number 7 is displayed)

The input "Start" should be a pulse with a length of approx. 1 seconds.

* Entry point after removing the signal "Abort". This signal deletes all outputs and interrupts the measuring process at any point (only in automatic mode). The specimen is vented (e.g. for emergency stop).

Sample printouts

This section shows some sample printouts of the tester via serial interface to a printer or PC.

Protocol printout

```

HeMaTech Prüftechnik, Siemensstraße 7, D-71409 Schwaikheim

Leak tester 3925-0050m1-00-00000000
    
```

SerNo	Pg	Date	Time	MeasVal	Unit	Result	Error
1	1	06112006	084713	1	Pascal	No leak	0
2	1	06112006	084728	0	Pascal	No leak	0
3	1	06112006	084742	0	Pascal	No leak	0
4	1	06112006	084758	0	Pascal	No leak	0
5	1	06112006	084820	0	Pascal	No leak	0
6	1	06112006	084837	0	Pascal	No leak	0
7	1	06112006	084852	0	Pascal	No leak	0
8	1	06112006	084908	294	Pascal	Leak	0
9	1	06112006	084728	68	Pascal	No leak	0
10	1	06112006	084942	69	Pascal	No leak	0
11	1	06112006	084958	122	Pascal	Rework	0
12	1	06112006	085013	^^^^^	Pascal	Coarse leak	0
13	1	06112006	085029	0	Pascal	No leak	0
14	1	06112006	085042	0	Pascal	No leak	0
15	1	06112006	085057	0	Pascal	No leak	0
16	1	06112006	085120	0	Pascal	No leak	0
17	1	06112006	085134	529	Pascal	Leak	0
18	1	06112006	085212	0	Pascal	No leak	0
19	1	06112006	085233	36	Pascal	No leak	0
20	1	06112006	085240	-----	Pascal	-----	4

etc. up to 50 test results per page.

Each page has a new page header.

Program parameters

HeMaTech Prüftechnik GmbH & Co KG, D-71409 Schwaikheim

Leak Tester 3925-0065-000-00000001

```

Program number_____ : 1
Program name_____ :hydraulic space
Workpiece_____ :dosing system
Operator_____ :Mueller
Last parameter change_____ :25012010
Print date_____ :-----

Fill pressure_____ : 1.00 bar      ON
Underfill pressure_____ : 0.80 bar
Underfill time_____ : 0.30 sec
Test pressure_____ : 0.90 bar      ON
Pressure tolerance_____ : 1.0 %

Fill time_____ : 3.00 sec
Stabilize time_____ : 3.00 sec
Pause time_____ : 1.00 sec
Auto zero time_____ : 0.50 sec
Measure time_____ : 3.00 sec
Vent time_____ : 1.00 sec      Off

Rework limit_____ : 100 Pascal  ON
Reject limit_____ : 200 Pascal  ON

Counter Accept_____ : 1
Counter Rework_____ : 0
Counter Reject_____ : 8
Counter Total_____ : 0

Fixture offset_____ : 0 Pa
Volume multiplier_____ :-.-----
Consecutive rejects_____ : 5

Protocol_____ :Ser #1
Record start_____ : 0.00 sec
Record end_____ : 10.50 sec
Envelope tolerance_____ : 1.00 %      Off
Envelope Start_____ : 0.00 sec
Envelope end_____ : 10.50 sec

```

Result memory

HeMaTech Prüftechnik GmbH & Co KG, D-71409 Schwaikheim

Leak Tester 3925-0065-00-00000001

Count	Program	Date	Time	Value	Unit	Result
-1	1	25012010	122146	415	Pascal	Reject
-2	2	25012010	110056	314	Pascal	Reject
-3	1	25012010	110040	320	Pascal	Reject
-4	2	25012010	110024	327	Pascal	Reject
-5	1	25012010	110008	358	Pascal	Reject
-6	2	25012010	105851	351	Pascal	Reject
-7	1	25012010	105835	365	Pascal	Reject
-8	2	25012010	105819	359	Pascal	Reject
-9	1	25012010	105803	415	Pascal	Reject
-10	2	25012010	105732	329	Pascal	Reject
-11	1	25012010	105716	437	Pascal	Reject
-12	1	25012010	105342	414	Pascal	Reject
-13	1	25012010	104926	410	Pascal	Reject
-14	1	25012010	103554	0	Pascal	Accept
-15	1	25012010	103427	-----	Pascal	ERROR 13

HeMaTech Prüftechnik, Siemensstraße 7, D-71409 Schwaikheim

Leak tester 3925-0065-00-00000000

Nummer	Programm	Date	Time	Value	Unit	Result
-1	1	06112006	085240	-----	Pascal	ERROR04
-2	1	06112006	085233	36	Pascal	No leak
-3	1	06112006	085212	0	Pascal	No leak
-4	1	06112006	085134	529	Pascal	Leak
-5	1	06112006	085120	0	Pascal	No leak
-6	1	06112006	085057	0	Pascal	No leak
-7	1	06112006	085042	0	Pascal	No leak
-8	1	06112006	085029	0	Pascal	No leak
-9	1	06112006	085013	-----	Pascal	Coarse leak
-10	1	06112006	084958	122	Pascal	Rework
-11	1	06112006	084942	69	Pascal	No leak
-12	1	06112006	084928	68	Pascal	No leak
-13	1	06112006	084908	294	Pascal	Leak
-14	1	06112006	084852	0	Pascal	No leak
-15	1	06112006	084837	0	Pascal	No leak
-16	1	06112006	084820	0	Pascal	No leak
-17	1	06112006	084758	0	Pascal	No leak
-18	1	06112006	084742	0	Pascal	No leak
-19	1	06112006	084728	0	Pascal	No leak
-20	1	06112006	084713	1	Pascal	No leak

etc. up to 50 test results/page

System parameters

HeMaTech Prüftechnik GmbH & Co KG, D-71409 Schwaikheim

Leak Tester 3925-0065-000-00000001

```

Type_____ :DHP0065
Hardware version_____ :1
Software version_____ :2.03
Software revision_____ :4
System MCU_____ :1.08
System DCU_____ :2.14
System CCU_____ :1.00
CPLD version_____ :1.00
-----
Job number_____ :P1
Serial number_____ :10000000
-----
Language_____ :English
Display brightness_____ :128
Color scheme_____ :Blue/White
-----
Interface 1_____ :RS232
Parameter Interface 1___ :115200 8 1 No      No      Line printer 0
Interface 2_____ :-----
Parameter Interface 2___ :9600  8 1 No      XON/XOFF Line printer 0
Format USB-Stick_____ :Line printer
-----
Analog input 0___ :12591, 63034,    -200.0000,    3000.0000, 0
Analog input 1___ :12541, 62851,     0.0000,     1.0005, 0
Analog input 2___ :  0, 65535,     0.0000,     1.0000, 0
Analog input 3___ :  0, 65535,     0.0000,     1.0000, 0
Analog input 4___ :  0, 65535,     0.0000,     1.0000, 0
Analog input 5___ :  0, 65535,     0.0000,     1.0000, 0
Analog input 6___ :  0, 65535,     0.0000,     1.0000, 0
Analog input 7___ :  0, 65535,     0.0000,     1.0000, 0
-----
Analog output 0___ : 3241, 16278,     0.0000,     2.0270, 0
Analog output 1___ : 3170, 15972,     0.0000,     1.0000, 0
Analog output 2___ : 3170, 15972,     0.0000,     1.0000, 0
Analog output 3___ : 3170, 15972,     0.0000,     1.0000, 0
-----
Program number: Min=1      Max=99      Std=1      Unt=X      Edt=1
Date_____ : Min=0000000000 Max=9999999990 Std=0000000000 Unt=X      Edt=0
Program name___ : Min=1      Max=23      Std=23      Unt=X      Edt=1
Workpiece_____ : Min=1      Max=23      Std=23      Unt=X      Edt=1
Operator_____ : Min=1      Max=23      Std=23      Unt=X      Edt=1
Fill pressure  : Min=0.10   Max=1.00    Std=1.00    Unt=bar    Edt=1
FillPressOnOff: Min=Off     Max=ON      Std=ON      Unt=X      Edt=2
Underfill pres: Min=0.10   Max=1.00    Std=0.80    Unt=bar    Edt=1
Underfill time: Min=0.00   Max=10.00   Std=0.30    Unt=sec    Edt=1
Test pressure  : Min=0.10   Max=1.00    Std=0.90    Unt=bar    Edt=1
TestPressOnOff: Min=ON      Max=ON      Std=ON      Unt=X      Edt=2
Pressure tol._ : Min=0.5     Max=10.0    Std=1.0     Unt=%      Edt=1
Fill time_____ : Min=0.10   Max=999.99  Std=3.00    Unt=sec    Edt=1
Stabilize time: Min=0.10   Max=999.99  Std=3.00    Unt=sec    Edt=1
Pause time_____ : Min=0.00   Max=999.99  Std=1.00    Unt=sec    Edt=1
Auto zero time: Min=0.00   Max=999.99  Std=0.50    Unt=sec    Edt=1
Measure time___ : Min=0.10   Max=999.99  Std=3.00    Unt=sec    Edt=1
Vent time_____ : Min=0.10   Max=999.99  Std=1.00    Unt=sec    Edt=1
Vent OnOff_____ : Min=Off     Max=ON      Std=Off     Unt=X      Edt=2
Unit_____ : Min=Pascal  Max=ml/min  Std=Pascal  Unt=X      Edt=2
Fixture offset: Min=-300   Max=300     Std=0       Unt=Pa     Edt=1
Volume multi___ : Min=0.000001 Max=9.999999 Std=1.000000 Unt=X      Edt=1
Rework_____ : Min=1      Max=2000    Std=100     Unt=X      Edt=1
Rework OnOff___ : Min=Off     Max=ON      Std=ON      Unt=X      Edt=2
Reject_____ : Min=1      Max=2000    Std=200     Unt=X      Edt=1
Reject OnOff___ : Min=ON      Max=ON      Std=ON      Unt=X      Edt=2
Cons. reject___ : Min=0       Max=999     Std=5       Unt=part   Edt=1
Protocol to___ : Min=Off     Max=USB-Stick Std=Ser #1  Unt=X      Edt=2
Record start___ : Min=0.00   Max=999.99  Std=0.00    Unt=sec    Edt=1

```

Record end___: Min=0.10 Max=999.99 Std=3.00 Unt=sec Edt=1
EnvelopeOnOff : Min=Off Max=ON Std=Off Unt=X Edt=2
EnvelopeTol___: Min=0.50 Max=25.00 Std=1.00 Unt=% Edt=1
EnvelopeStart_: Min=0.00 Max=999.99 Std=0.00 Unt=sec Edt=1
EnvelopeEnd___: Min=0.10 Max=999.99 Std=3.00 Unt=sec Edt=1

Initial menu__ :Main menu
Test methode__ :PressureDrop Diff
I/O configur._ :Automatic
NumDec_Pa_____ :0
NumDec_mbar____ :2
NumDec_psi_____ :4
NumDec_mmWC_____ :1
NumDec_mmHg_____ :2
NumDec_ml/min____ :1
PressureCorr._ :0.5 %
Pres.limit pos:0.090
Pres.limit neg:-0.100
E4 limit min___:-100
E4 limit max___ :100
E10 limit_____:-100
E13 limit_____:-10
Gross leak_____ :540

Operating time:00000194:20
Test cycles___ :00005184

Error	Number	Error	Number	Error	Number	Error	Number	Error	Number
01	000000	11	000000	21	000000	31	000000	41	-----
02	000000	12	000000	22	000000	32	000000	42	-----
03	000000	13	000001	23	000000	33	000000	43	-----
04	000000	14	000000	24	000000	34	000000	44	-----
05	000000	15	000000	25	000000	35	000000	45	-----
06	000000	16	000000	26	000000	36	000000	46	-----
07	000000	17	000000	27	000000	37	000000	47	-----
08	000000	18	000000	28	000000	38	000000	48	-----
09	000000	19	000000	29	000000	39	000000	49	-----
10	000000	20	000000	30	000000	40	000000	50	-----

Appendix

This section provides you with an overview of plug assignment, pneumatic diagrams for overpressure and vacuum, the declaration of conformity and technical data.

Plug assignment

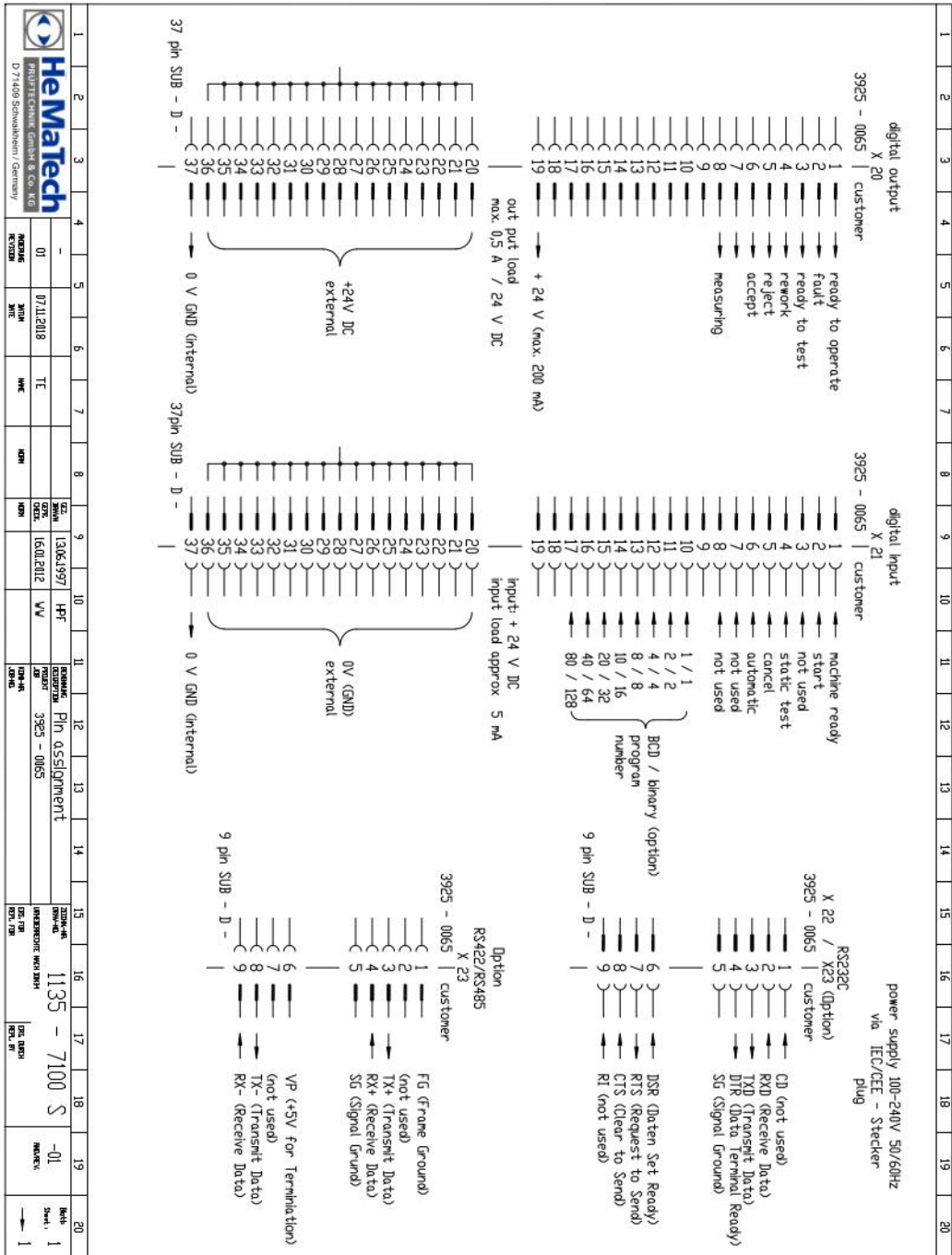

HeMaTech Prüftechnik GmbH & Co. KG D-71489 Schwabheim / Germany		ARTICLE NUMBER	01	DATE	07.11.2018	TECHNICAL DRAWING	TE	DATE	16.01.2012	VERSION	V1	REVISION	Pin assignment	3925 - 0065	DATE	11.35	SCALE	7:100	UNIT	S	REVISION	-01	DATE	11.35	SCALE	7:100	UNIT	S
------------------------------------------------------------------------------	--	----------------	----	------	------------	-------------------	----	------	------------	---------	----	----------	----------------	-------------	------	-------	-------	-------	------	---	----------	-----	------	-------	-------	-------	------	---

Technical Data

Program memory	battery buffered RAM
Measuring transducer	temperature compensated measuring converter for differential pressure, with 1,4 bar/g pressure relief.
Measuring range	0 ... 2000 Pa
Resolution	Display 1 Pa, via high-resolution SigmaDelta A / D converter
Measuring value display:	Full graphics display (320 × 240 Pixel) Measuring value in Pa, mmWC, mbar, psi, mmHg, ml/min
Keyboard	Alpha numerical input field
Test programs	99
Filling and testing pressure	0.2 ... 6.0 bar/g
Test parameters	Program number: Filling pressure: Underfilling pressure: Test pressure: Pressure tolerance: 1.0 ... 10.0 % v.E. Filling time: 0.1 ... 999.9 sec, Underfilling time: 0.1 ... 9.99 sec, Stabilization time: 0.1 ... 999.9 sec, Measuring time: 0.1 ... 999.9 sec, Venting time: 0.1 ... 999.9 sec, Measuring value unit: Pa, mmWC, mbar, psi, mmHG, ml/min, Tare of device: Volume factor: Rework from ... Leak from ... Series fault from: x parts Leak or coarse leak Enveloping curve tolerance: 0.50 ... 25.00 % Enveloping curve: ON/OFF Reference curve start: 0.00 ... 999.99 sec Reference curve end: 0.10 ... 999.99 sec Enveloping curve start: 0.00 ... 999.99 sec Enveloping curve end: 0.10 ... 999.99 sec
Write protection	via key switch
Result signals	No leak, Rework 1 and Leak

Interfaces	1 parallel interface (machine control) (maximum 96 digital inputs/outputs)
Control inputs	1 bit each for Automatic, Machine ready, Start, Flooding and Abort 8 bit program selection
Control outputs	1 bit each for Ready for operation, Ready for test, Error, No leak, Rework, Leak, Measuring
Serial interfaces, max. 4, depending on design	RS 232C for transfer of parameters, counter counts and measuring values, external configuration, only for external control Optional 2. Serial interface Fieldbus: Profibus, Profinet
USB interface	USB 2.0 for transfer of parameters, counter counts and measuring values
Structure	Compact housing
Dimensions	The device dimensions in W x H x D are 357 x 142 x 420 mm
Electric power supply	100-240 V , 50/60 Hz (without system transfer)
Device protection	Fuse unit 1× 2.0 AT (5 × 20 mm slow) Order-number: 8834-0313
Power input	maximum 100 VA
Supply air	min. 1,5 bar/ü > test pressure, max. 10 bar/ü, dry, oil free and filtered
Connections	Supply air connection G 1/4 Test connection G 1/8
Venting	via silencer G 1/4
Weight	approx. 8 kg
Order-number	3925-0065
(Subject to alterations)	

EC - Declaration of Conformity



Dichtheitsprüfung Durchflussprüfung Volumenprüfung Prüfsysteme Prüfmaschinen

Siemensstraße 7 Tel. +49 (0)71 95/13 69 -0 E-mail: info@hematech.de
D-71409 Schwaikheim Fax +49 (0)71 95/13 69 -29 Internet: www.hematech.de

EG – KONFORMITÄTSERKLÄRUNG

EC DECLARATION OF CONFORMITY
ATTESTATION DE CONFORMITE C.E.

Produktbezeichnung: Dichtheitsprüfgerät 3925- 0065
Product name: Typen- Nr.: 3925-0065
Désignation du produit:

Das Produkt stimmt mit den Vorschriften folgender Europäischer Richtlinien überein:
This product meet the requirements of the following European directives:
Les produits répondent aux exigences des Directives C.E. suivantes:

89/336/EWG 89/336/EEC 89/336/C.E.E.	EMV – Richtlinie * Electromagnetic Compatibility Directive * Directives concernant la compatibilité électromagnétique *
73/23/EWG 73/23/EEC 73/23/C.E.E.	Niederspannungsrichtlinie * EC -Low -Voltage Directive * Directives concernant la basse tension *

* einschließlich Änderungen und Umsetzung durch das EMVG und Gerätesicherheitsgesetz
* including alterations and German realization by the EMC law and the instruments safety law
* y compris les modifications et la réalisation allemande par la loi cocernant la compatibilité électromagnétique et la sécurité d'appareils

Die Übereinstimmung mit den Vorschriften dieser Richtlinien wird nachgewiesen durch die
Einhaltung der folgenden Normen:
Conformity with the requirements of these Directives is proven by complete adherence to the following standards:
La conformité avec les exigences de ces directives est prouvée par l'observation complète des normes suivantes:

EN 50 081-1 / EN 50 082-2 / EN 61 010-1

Diese Erklärung wird gegeben von:
This declaration is given of:
Cette attestation est donnée de:

HeMaTech Prüftechnik GmbH & Co. KG
Siemenstrasse 7
D 71409 Schwaikheim

Harald Hellerich
Geschäftsführer

Schwaikheim, 11.10.2018

HeMaTech Prüftechnik GmbH & Co.KG

Sitz der Gesellschaft: D 71409 Schwaikheim
HRA 2216 Registergericht Stuttgart
Ust-Ident-Nr: DE 914 209 649

Persönlich haftender Gesellschafter:
HeMaTech Verwaltungsgesellschaft mbH
Sitz der Gesellschaft: D 71409 Schwaikheim
HRB 264919 Registergericht Stuttgart
Geschäftsführer: Harald Hellerich

SWIN Kreissparkasse Waiblingen
SWIFT/BIC: SOLADES1WBN

Dresdner Bank AG Stuttgart
SWIFT/BIC: DRESDEFF 600

BLZ: 602 500 10 Kto.: 150 112 11

BLZ: 600 600 00 Kto.: 401 498 400
IBAN: DE 28600800000401498400



Index

A

Acknowledging errors 93
 Adjusting the filling pressure manually 66, 68
 Adjusting the testing pressure manually 66, 68
 Adjusting the vacuum testing pressure manually 69
 ALPHA, control key 22
 Arrow Keys 22
 Automatic 30, 31
 Automatic mode
 without leak simulation 34
 Automatic mode
 Sequencer 33
 Automatic mode
 with leak simulation 34
 Automatic mode
 Static Test (Flooding) 34
 Automatic operation 99

B

Back view 20
 Backup 30
 Bus address 57

C

Choosing the measuring value unit 44
 Code for measuring result 53
 Command bar 28
 Command reference PLC95 63
 Connecting compressed air 23, 24
 Connecting serial interface(s) 26
 Connecting test medium 23, 24
 Connecting the electric power supply 26
 Connecting the machine control 25
 Connecting the reference volume 24
 Connecting the specimen 24
 Connecting the supply air 24
 Connections 20
 Contact address: 122
 Control commands 30
 Control elements 21
 Control Keys 22
 Control panel 21
 Copying a test program 48

Cycle Test 30

Cycle Test, manual menu 35

D

Data backup 75
 Data bit 50
 Data output 30, 71
 Data up- / download 75
 Date & time 49
 setting 49
 Date & Time 30
 Delete 30, 70
 Deleting result counters 70
 Deleting result memories 70
 Deleting test programs 70
 Determining the reference curve 37
 Device design 17
 Differential pressure method 13
 Display 28, 30
 Setting the brightness 80
 Setting the contrast 80
 Setting the language 80
 Setting the mode 80

E

EC - Declaration of Conformity 117
 Edit a program name 42
 Edit test pressure 43
 Edit the device tare weight 44
 Edit the filling pressure 42
 Edit the filling time 43
 Edit the measuring time 44
 Edit the name of the testing person 42
 Edit the number of sequencer cycles 65
 Edit the pause time 43, 65
 Edit the pressure tolerance 43
 Edit the stabilization time 43
 Edit the tare time 43
 Edit the venting time 44
 Edit the volume factor 45
 Edit the work piece name 42
 Electronics 17
 ENTER, control key 22
 EnvelopCurveEnd 46
 EnvelopCurveStart 46
 EnvelopCurveTolerance 45

Error 00 94
 Error 01 94
 Error 03 33, 94
 Error 04 94
 Error 10 94
 Error 13 87, 95
 Error 14 95
 Error 15 95
 Error 16 95
 Error 19 95
 Error 20 95
 Error 23 96
 Error 24 96
 Error 25 96
 Error 26 96
 Error 27 96
 Error 28 96
 Error 37 97
 Error 38 97
 Error 39 97
 Error 40 33, 38, 97
 Error counter 30
 Error messages 94
 Error number 54
 Error pressure control 84
 Errors 93
 Exceeding a value 54
 F
 File01 52
 File02 55
 Filling 14
 Filling curve 30
 Filling curve display 32, 36
 Flooding 30
 Flow chart
 Automatic operation 100
 Minimal operation 104
 Semi-automatic operation 102
 Flow meter, connection 19
 Format 51
 Format File01 52
 Format File02 55
 Format filling curve 64
 Format line printer 50
 Format ProfiBus 57
 Format REGISTER-PL 60
 Format REGISTER-PL+ZÜ 60
 Format REGISTER-PL+ZÜ+PS 60
 Front view 19
 H
 Help bar 29
 I
 Initialization 27
 Input mode 29
 Installation 11
 Intended use 6
 Interface setup 50
 Interface(s) 30
 Intervention limit
 for leaks 45
 for rework 45
 K
 Key switch 21
 L
 LC-Display 19
 Leak simulation 91
 M
 Main menu 28, 30, 31
 Mains connection 26
 Maintenance 11, 92
 Maintenance contract 92
 Maintenance plan 92
 Manual 30, 35
 Manual mode
 Sequencer 38
 Manual operation 35
 with or without leak simulation 35
 Manual static test 39
 Measuring 14
 Measuring data
 of File01 52
 of File02 55
 Measuring result, code 53
 Menu bar 28
 Menu structure 30
 Minimal operation 104
 Model designation 6
 O
 Operation 11
 Operation data 30, 74
 Operation mode
 Automatic 31
 Manual 35

- Operation, principle 29
- Options 30, 86
- Ordering spare parts 6
- Output channel for test results 45
- Output of test programs 72
- P
- Parity 51
- Performance characteristics 16
- Performing the self-test 88
- Peripheral equipment 23
- Plausibility 47
- PLC95.GSD 59
- Plug assignment 112, 113
- Pneumatic diagram
 - Overpressure device 114
 - Vacuum device 113
- Pneumatics 17
- Precision needle valve 19
- Pressure course in test system 14
- Pressure system 30
- Printer setup 50
- Product description 13
- Profibus 30
 - Inputs and outputs 58
- Program overview 30
- Program parameters 107
- Protocol 51
- Protocol printout 106
- R
- RefCurveEnd 46
- RefCurveStart 45
- Reference 30
- Reference curve 30
- Remote control 60
- Remote control, examples 63
- Repair 11
- Result counter 30, 74
- Result memory 30, 73, 108
- s
- Safety notes 10, 12
- Sample printouts 106
- Saving the test program 46
- Scope of delivery 18
- Sequencer 30, 33, 65
- Sequencer cycles 65
- Sequencer pause time 65
- Sequencer setup 65
- Serial #1 30
- Serial #2 30
- Serial 3 30
- Serial 4 30
- Serial number 6
- Setting the pressure control 83
- Setting the start screen options 86
- Setting the vacuum 69
- Setting the vacuum testing pressure manually 69
- Setting up a PC interface 52, 64
- Setting up a Profibus interface 57
- Setting up an interface for a line printer 50
- Setting up an interface for Profibus 57
- Setting up interfaces 50
- Setting up test programs 41
- Setting up the device for specimen 90
- Setting up the filling/testing pressure 66
- Settings 30, 79
- Setup of machine control interface 86
- Setup of machine interface 86
- SHIFT, control key 22
- Showing filling curves 78
- Showing system parameters 81
- Showing the error counter status 76
- Showing the program overview 71
- Showing the reference curve 77
- Showing the system status 85
- Signal exchange 98
- Software-Version 6
- Specifying series faults 45
- Specifying the data type 76
- Speed 50
- Stabilizing 14
- Start-up 23
- Static Test
 - Automatic 34
 - Manual operation 39
 - with or without leak simulation 40
- Static Test (Flooding) 30
- Status field 19
- Status fields 21
- Stop bit 50

Structure of commands 61, 62
Sub-D socket 20
Supply air connection 20
Switching OFF 26
Switching ON 26
Switching the device ON 26
Symbols 12
System parameters 30, 81, 109
System status 30, 85

T

Technical Data 115
Test medium 13
 Connection 20
Test program 30
Test programs
 changing 42
 Setup 41
Testing process 14

Testing the tester 88
Testing without filling pressure 90
Time-way diagram 101, 103, 105
Transfer rate 50
Transport damage 6
Trend measurement 90
Trouble Shooting Chart 94
Type plate 6, 20

u

Underfilling: 42

v

View of device 19

w

Warranty 7
Working principle 17
Write protection switch 19, 29

Contact address:

HeMaTech Prüftechnik GmbH & Co. KG
Siemensstrasse 7
DE-71409 Schwaikheim
Phone +49 (0)71 95/13 69 0
Fax +49 (0)71 95/13 69 29
Internet <http://www.hematech.de>

Notes: